



**НОГОЗ®**

**ELECTRIC**

эксперт в области **освещения**



**КАТАЛОГ**  
**2019-2020**

[www.horozelektrik.com](http://www.horozelektrik.com)



**HOROZ®**

**ELECTRIC**



[www.facebook.com/horozelectric](https://www.facebook.com/horozelectric)



[twitter.com/HorozElectric](https://twitter.com/HorozElectric)



[www.linkedin.com/company/horozk-elektrik-ve-elektronik-tic-koll-siti](https://www.linkedin.com/company/horozk-elektrik-ve-elektronik-tic-koll-siti)

**KaçmazGrup**

[www.horozelektrik.com](http://www.horozelektrik.com)



## эксперт в области **освещения**

Светодиодные лампы, трубки, капсулы.....	2	Детекторы, датчики управления светом, таймеры, беспроводные переключатели.....	110
<b>Светодиодные встраиваемые светильники.....</b>	<b>14</b>	<b>NEW</b> Диммеры, выключатели, розетки.....	<b>111</b>
Светодиодные накладные светильники.....	22	<b>NEW</b> Автоматические выключатели.....	113
<b>NEW</b> Светодиодные встраиваемые панели.....	<b>24</b>	Патроны.....	115
Системы трекового освещения.....	26	Стартеры, клипсы, соединители кабель, клеммы, изолента...116	
Светодиодные подвесные светильники и люстры.....	32	Удлинитель, соединители, клеммы.....	117
Светодиодные подвесы.....	44	TEB Electric.....	118
Декоративные подвесы.....	45	Колодки и удлинители.....	120
Гирлянды.....	48	Вилки и выключатели.....	131
Декоративные настенно-потолочные светильники.....	49	Розетки-тройники.....	134
Светодиодные потолочные светильники.....	50	Удлинитель кабеля.....	135
Светодиодные настенные светильники.....	52	Пластиковые вентиляторы...136	
Светодиодные потолочные светильники.....	54	Потолочные светильники с датчиком движения.....	137
Светильники для ванной комнаты, подсветки картин и зеркал.....	60	Водонепроницаемые светильники.....	138
Торшеры.....	65	Светодиодные светильники.....	149
Настольные лампы.....	66	Светильники под лампочку..151	
Ночные светильники.....	71	Светильники с двумя патронами.....	156
Линейные светильники.....	72	Светильники (квадраты).....	157
Пыле-влагозащищённые светильники.....	84	Садово-парковые светильники.....	159
Садово-парковые светильники.....	85	Боксы под автоматические выключатели.....	163
Светильники на солнечных батареях.....	92		
Встраиваемые грунтовые и лестничные светильники.....	95		
Светодиодные ленты и драйверы.....	98		
<b>NEW</b> RGB-контроллеры, неон.....	<b>99</b>		
Драйверы, гирлянды.....	104		
Аварийные светильники и фонари.....	105		



**HOROSZ ELECTRIC**

LED Лампы / LED Трубки / LED Капсулы

**PREMIER**

- 175-250V / 50-60Hz
- Срок службы 25 000 Часов
- 3000K / 4200K / 6400K

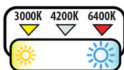

**NEW PRODUCT**



	PREMIER-7	PREMIER-12	PREMIER-14	PREMIER-17	PREMIER-20	PREMIER-22
	001-006-0007	001-006-0012	001-006-0014	001-006-0017	001-006-0020	001-006-0022

Power	: 7 W	12 W	14 W	17 W	20 W	22 W
Luminous Flux	: 700 lm	1200 lm	1400 lm	1700 lm	2000 lm	2200 lm
Sizes (mm)	: A:55 B:95	A:60 B:108	A:60 B:105	A:60 B:111	A:65 B:120	A:70 B:140

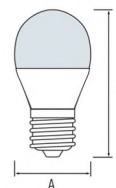

**HOROSZ ELECTRIC**

LED Лампы  
LED Трубки  
LED Капсулы



3 6 0

**INFINITY**

001 018 0008

- 220-240V / 50-60Hz
- Срок службы 25 000 Часов
- 600 Lm
- 3000K / 4200K / 6400K



360°

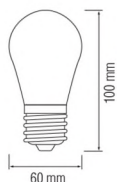

D I M M A B L E

**EXPERT-10**

001 021 0010

- 220-240V / 50-60Hz
- Срок службы 25 000 Часов
- 900 lm
- 3000K / 4200K / 6400K



DIMMABLE

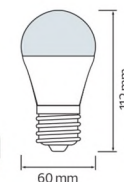

## DURAMAX-12

- 100-250V / 50-60Hz
- Срок службы 30 000 Часов
- 1080 lm
- 6400K
- 3,7V 2200mAh Li-ion Battery
- Emergency Work: 4.5W – 500 lm

001 055 0012

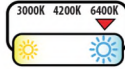

Rechargeable  
Emergency  
LED  
Bulb



Emergency Lighting  
Duration: 3 Hours

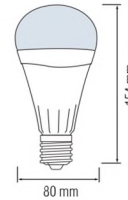

## FONIX

- 175-250V / 50-60Hz
- Срок службы 25 000 Часов
- 3000K / 4200K / 6400K

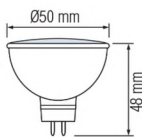
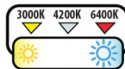

	FONIX-4	FONIX-6	FONIX-8
	001-001-0004	001-001-0006	001-001-0008
Power	4 W	6 W	8 W
Luminous Flux	250 lm	390 lm	630 lm



## PLUS

- 175-250V / 50-60Hz
- Срок службы 25 000 Часов
- 3000K / 4200K / 6400K

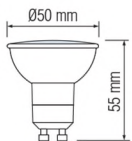
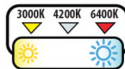

	PLUS-4	PLUS-6	PLUS-8
	001-002-0004	001-002-0006	001-002-0008
Power	4 W	6 W	8 W
Luminous Flux	250 lm	390 lm	630 lm



## D I M M A B L E

## VISION-6

001 022 0006

- 220-240V / 50-60Hz
- Срок службы 25 000 Часов
- 390 lm
- 3000K / 4200K / 6400K

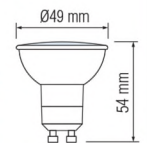



### ULTRA

- 175-250V / 50-60Hz
- Срок службы 25 000 Часов
- 3000K / 4200K / 6400K

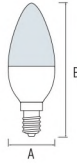
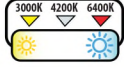

	ULTRA-4	ULTRA-6	ULTRA-10	ULTRA-12
	001-003-0004	001-003-0006	001-003-0010	001-003-0012

Power	: 4 W	6 W	10 W	12 W
Luminous Flux	: 250 lm	480 lm	1000 lm	1200 lm
Sizes (mm)	: A: 37 B: 100	A: 37 B: 100	A: 37 B: 110	A: 37 B: 110



### CRAFT

- 175-250V / 50-60Hz
- Срок службы 25 000 Часов
- 3000K / 4200K / 6400K

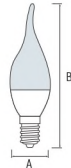
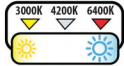

	CRAFT-4	CRAFT-6	CRAFT-10	CRAFT-12
	001-004-0004	001-004-0006	001-004-0010	001-004-0012

Power	: 4 W	6 W	10 W	12 W
Luminous Flux	: 250 lm	480 lm	1000 lm	1200 lm
Sizes (mm)	: A: 37 B: 125	A: 37 B: 125	A: 37 B: 135	A: 37 B: 135



### ELITE

- 175-250V / 50-60Hz
- Срок службы 25 000 Часов
- 3000K / 4200K / 6400K
- E14 & E27

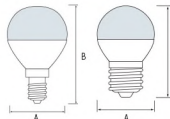
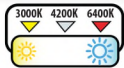

	ELITE-4	ELITE-6	ELITE-10	ELITE-12
	001-005-0004	001-005-0006	001-005-0010	001-005-0012

Power	: 4 W	6 W	10 W	12 W
Luminous Flux	: 250 lm	480 lm	1000 lm	1200 lm
Sizes (mm)	: A: 45 B: 78	A: 45 B: 78	A: 45 B: 88	A: 45 B: 88



### REFLED

- 175-250V / 50-60Hz
- Срок службы 25 000 Часов
- 4200K

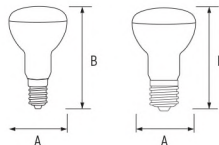
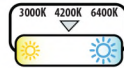

	REFLED-4	REFLED-6	REFLED-10	REFLED-12
	001-039-0004	001-040-0006	001-041-0010	001-042-0012

Power	: 4 W	6 W	10 W	12 W
Luminous Flux	: 210 lm	480 lm	720 lm	1000 lm
Lamp Holder	: E14	E14	E27	E27
Sizes	: A: 39 B: 68	A: 50 B: 86	A: 63 B: 100	A: 80 B: 115



## TORCH

- 175-250V / 50-60Hz
- Срок службы 25 000 Часов

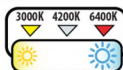

**NEW**  
PRODUCT



	TORCH-20	TORCH-30	TORCH-40	TORCH-50	TORCH-80	TORCH-100
	001-016-0020	001-016-0030	001-016-0040	001-016-0050	001-016-0080	001-016-0100
Power	20 W	30 W	40 W	50 W	80 W	100 W
Color Temperature	3000K/4200K/6400K	3000K/4200K/6400K	3000K/4200K/6400K	3000K/4200K/6400K	6400K	6400K
Lamp Holder	E27	E27	E27	E27	E27	E27 / E40
Luminous Flux	2000 lm	3000 lm	4000 lm	5000 lm	8000 lm	10000 lm
Sizes (mm)	A: 80 B: 150	A: 101 B: 179	A: 119 B: 209	A: 139 B: 239	A: 139 B: 250	A: 160 B: 285

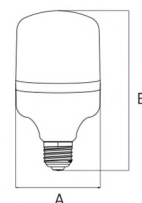

## UFO PRO

- 175-250V / 50-60Hz
- Срок службы 25 000 Часов
- 6400K

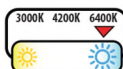

**NEW**  
PRODUCT



	UFO PRO-30	UFO PRO-50	UFO PRO-70
	001-056-0030	001-056-0050	001-056-0070
Power	30 W	50 W	70 W
Luminous Flux	3000 lm	5000 lm	7000 lm
Sizes (mm)	A: 135 B: 115	A: 170 B: 140	A: 195 B: 160

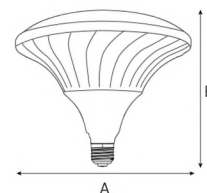

## UFO-15

001 044 0015

- 160-250V / 50-60Hz
- Срок службы 25 000 Часов
- 900 lm
- 4200K

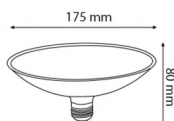
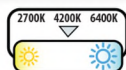

## GLOBE

- 175-250V / 50-60Hz
- Срок службы 25 000 Часов
- 3000K / 4200K / 6400K

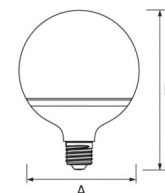
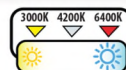

	GLOBE-16	GLOBE-20
	001-019-0016	001-020-0020
Power	16 W	20 W
Luminous Flux	1400 lm	1650 lm
Sizes (mm)	A: 95 B: 136.5	A: 120 B: 161





**HOROSZ ELECTRIC**

LED Лампы / LED Трубки / LED Капсулы

**FIREFLUX**

001 048 0005



**3 Modes**

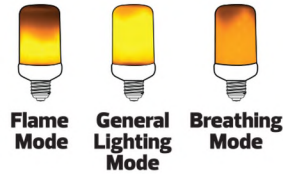

- 100-250V / 50-60Hz
- Срок службы 25 000 Часов
- 117 lm
- 1500K

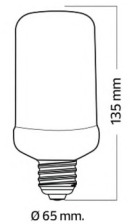

**RAINBOW**

001 017 0001



**YELLOW**

- 105 lm

**RED**

- 34 lm

**GREEN**

- 68 lm

**BLUE**

- 12 lm

**WHITE**

- 120 lm

- 220-240V / 50-60Hz
- Срок службы 25 000 Часов

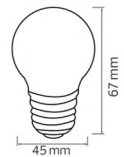

**SPECTRA**

001 017 0003



**YELLOW**

- 315 lm

**RED**

- 102 lm

**GREEN**

- 205 lm

**BLUE**

- 38 lm

- 175-250V / 50-60Hz
- Срок службы 25 000 Часов

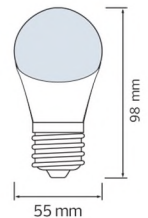

**LED TUBE**

- 175-250V / 50-60Hz
- Срок службы 25 000 Часов
- 6400K

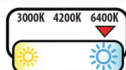

LED TUBE-60	LED TUBE-120	LED TUBE-150
002-001-0009	002-001-0018	002-001-0024

Power	: 9 W	18 W	24 W
Luminous Flux	: 750 lm	1450 lm	2400 lm
Length (mm)	: L: 600	L: 1200	L: 1500

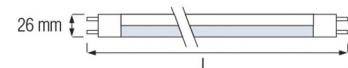



## FILAMENT CANDLE

- 220-240V / 50-60Hz
- Срок службы 20 000 Часов
- 2700K / 4200K

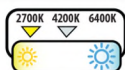

FILAMENT CANDLE-4	FILAMENT CANDLE-6
001-013-0004	001-013-0006

Power	:	4 W	6 W
Luminous Flux	:	420 lm	630 lm

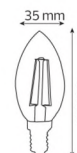

## FILAMENT FLAME

- 220-240V / 50-60Hz
- Срок службы 20 000 Часов
- 2700K / 4200K

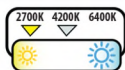

FILAMENT FLAME-4	FILAMENT FLAME-6
001-014-0004	001-014-0006

Power	:	4 W	6 W
Luminous Flux	:	420 lm	630 lm



## FILAMENT GLOBE

- 220-240V / 50-60Hz
- Срок службы 20 000 Часов
- 2700K / 4200K

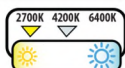

FILAMENT GLOBE-6	FILAMENT GLOBE-8	FILAMENT GLOBE-10
001-015-0006	001-015-0008	001-015-0010

Power	:	6 W	8 W	10 W
Luminous Flux	:	630 lm	840 lm	1050 lm

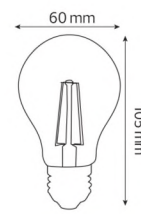



### TOLEDO

■ 220-240V / 50-60Hz  
■ Срок службы 20 000 Часов

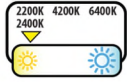

**NEW**  
PRODUCT

AMBER  
COLOR



TITANIUM  
COLOR

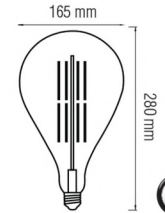

TOLEDO

001-049-0008

Power	:	8 W
Luminous Flux	:	620 lm (Amber) / 250 lm (Titanium)
Color Temperature	:	2200K (Amber) / 2400K (Titanium)

### GINZA

■ 220-240V / 50-60Hz  
■ Срок службы 20 000 Часов

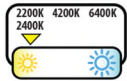

**NEW**  
PRODUCT

TITANIUM  
COLOR



AMBER  
COLOR

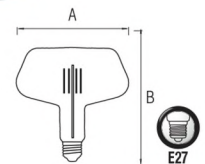

GINZA

001-050-0008

GINZA-XL

001-050-0008

Power	:	8 W	8 W
Luminous Flux	:	620 lm (Amber) / 250 lm (Titanium)	620 lm (Amber) / 250 lm (Titanium)
Color Temperature	:	2200K (Amber) / 2400K (Titanium)	2200K (Amber) / 2400K (Titanium)
Sizes (mm)	:	A: 180 B: 190	A: 230 B: 200

### ENIGMA

■ 220-240V / 50-60Hz  
■ Срок службы 20 000 Часов

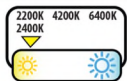

**NEW**  
PRODUCT

AMBER  
COLOR



TITANIUM  
COLOR

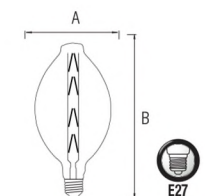

ENIGMA

001-051-0008

ENIGMA-XL

001-051-0008

Power	:	8 W	8 W
Luminous Flux	:	620 lm (Amber) / 250 lm (Titanium)	620 lm (Amber) / 250 lm (Titanium)
Color Temperature	:	2200K (Amber) / 2400K (Titanium)	2200K (Amber) / 2400K (Titanium)
Sizes (mm)	:	A: 120 B: 225	A: 185 B: 345

**PARADOX**

■ 220-240V / 50-60Hz  
■ Срок службы 20 000 Часов

**PARADOX-XL**

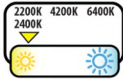

**NEW  
PRODUCT**

TITANIUM  
COLOR

AMBER  
COLOR



FILAMENT LED

	PARADOX	PARADOX-XL
	001-052-0008	001-052-0008

Power	:	8 W	8 W
Luminous Flux	:	620 lm (Amber) / 250 lm (Titanium)	620 lm (Amber) / 250 lm (Titanium)
Color Temperature	:	2200K (Amber) / 2400K (Titanium)	2200K (Amber) / 2400K (Titanium)
Sizes (mm)	:	A: 120 B: 270	A: 188 B: 400

**ORIGAMI**

■ 220-240V / 50-60Hz  
■ Срок службы 20 000 Часов

**ORIGAMI-XL**

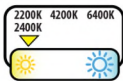

**NEW  
PRODUCT**

AMBER  
COLOR

TITANIUM  
COLOR

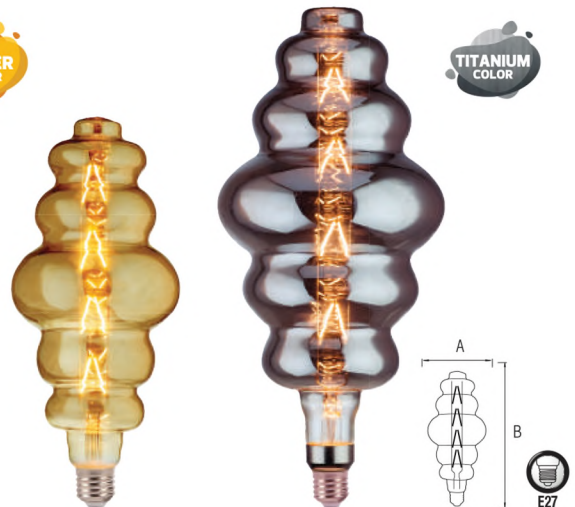

FILAMENT LED

	ORIGAMI	ORIGAMI-XL
	001-053-0008	001-053-0008

Power	:	8 W	8 W
Luminous Flux	:	620 lm (Amber) / 250 lm (Titanium)	620 lm (Amber) / 250 lm (Titanium)
Color Temperature	:	2200K (Amber) / 2400K (Titanium)	2200K (Amber) / 2400K (Titanium)
Sizes (mm)	:	A: 120 B: 270	A: 180 B: 400

**ELLIPTIC**

■ 220-240V / 50-60Hz  
■ Срок службы 20 000 Часов

**ELLIPTIC-XL**

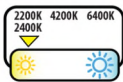

**NEW  
PRODUCT**

TITANIUM  
COLOR

AMBER  
COLOR



FILAMENT LED

	ELLIPTIC	ELLIPTIC-XL
	001-054-0008	001-054-0008

Power	:	8 W	8 W
Luminous Flux	:	620 lm (Amber) / 250 lm (Titanium)	620 lm (Amber) / 250 lm (Titanium)
Color Temperature	:	2200K (Amber) / 2400K (Titanium)	2200K (Amber) / 2400K (Titanium)
Sizes (mm)	:	A: 95 B: 340	A: 115 B: 460



### RUSTIC VINTAGE

- 220-240V / 50-60Hz
- Срок службы 20 000 Часов
- 2200K

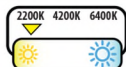

AMBER COLOR

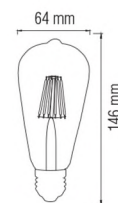

RUSTIC VINTAGE - 4

RUSTIC VINTAGE - 6

001-029-0004

001-029-0006

Power	:	4 W	6 W
Luminous Flux	:	360 lm	540 lm

### RUSTIC GLOBE

- 220-240V / 50-60Hz
- Срок службы 20 000 Часов
- 2200K

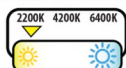

AMBER COLOR

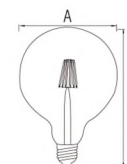

RUSTIC GLOBE - 4

RUSTIC GLOBE - 6

001-030-0004

001-030-0006

Power	:	4 W	6 W
Luminous Flux	:	360 lm	540 lm
Sizes (mm)	:	A: 95 B: 128	A: 125 B: 172

### RUSTIC TUBE

- 220-240V / 50-60Hz
- Срок службы 20 000 Часов
- 2200K

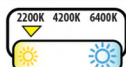

AMBER COLOR

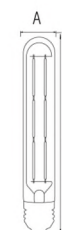

RUSTIC TUBE - 6

RUSTIC TUBE - 8

001-033-0006

001-033-0008

Power	:	6 W	8 W
Luminous Flux	:	540 lm	720 lm
Sizes (mm)	:	A: 30 B: 185	A: 30 B: 235

### RUSTIC STAR - 6

001 031 0006

- 220-240V / 50-60Hz
- Срок службы 20 000 Часов
- 540 lm
- 2200K

AMBER COLOR

6W

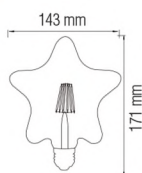
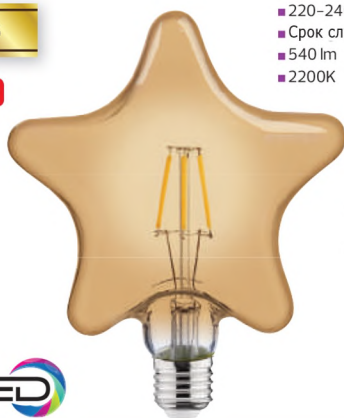

### RUSTIC HEART - 6

001 032 0006

- 220-240V / 50-60Hz
- Срок службы 20 000 Часов
- 540 lm
- 2200K

AMBER COLOR

6W

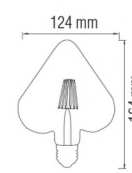

**RUSTIC DIAMOND**

- 220-240V / 50-60Hz
- Срок службы 20 000 Часов
- 2200K

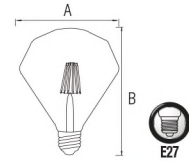
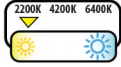

	RUSTIC DIAMOND - 4	RUSTIC DIAMOND - 6
	001-034-0004	001-034-0006
Power	4 W	6 W
Luminous Flux	360 lm	540 lm
Sizes (mm)	A: 95 B: 128	A: 120 B: 155

**RUSTIC CRYSTAL**

- 220-240V / 50-60Hz
- Срок службы 20 000 Часов
- 2200K

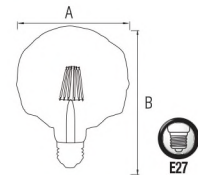
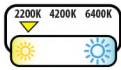

	RUSTIC CRYSTAL - 4	RUSTIC CRYSTAL - 6
	001-036-0004	001-036-0006
Power	4 W	6 W
Luminous Flux	360 lm	540 lm
Sizes (mm)	A: 95 B: 120	A: 125 B: 160

**RUSTIC TWIST**

- 220-240V / 50-60Hz
- Срок службы 20 000 Часов
- 2200K

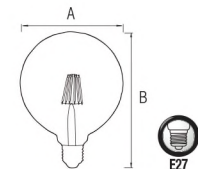
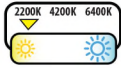

	RUSTIC TWIST - 4	RUSTIC TWIST - 6
	001-038-0004	001-038-0006
Power	4 W	6 W
Luminous Flux	360 lm	540 lm
Sizes (mm)	A: 95 B: 120	A: 125 B: 160

**RUSTIC PYRAMID - 6**

- 220-240V / 50-60Hz
- Срок службы 20 000 Часов
- 540 lm
- 2200K

001 035 0006

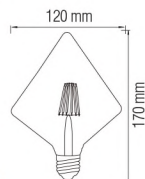

**RUSTIC MERIDIAN - 6**

- 220-240V / 50-60Hz
- Срок службы 20 000 Часов
- 540 lm
- 2200K

001 037 0006

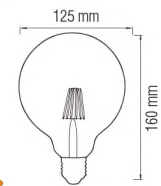



### PETA

- 220-240V / 50-60Hz
- Срок службы 25 000 Часов
- 2700K / 4200K / 6400K

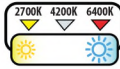

	PETA-4	PETA-6	PETA-8	PETA-10
	001-045-0004	001-045-0006	001-045-0008	001-045-0010
Power	4 W	6 W	8 W	10 W
Luminous Flux	330 lm	480 lm	680 lm	800 lm
Sizes (mm)	A: 15,9 B: 48,7	A: 15,7 B: 60,5	A: 18,4 B: 55	A: 18,4 B: 63

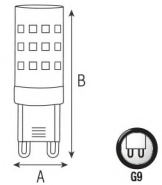

### DECO

- 220-240V / 50-60Hz
- Срок службы 25 000 Часов
- 2700K / 4200K / 6400K

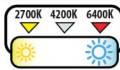

	DECO-3	DECO-7
	001-023-0003	001-023-0007

Power	3 W	7 W
Luminous Flux	300 lm	630 lm
Sizes (mm)	A: 16 B: 48	A: 16,3 B: 55,5

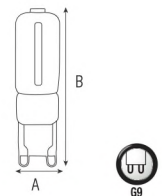

### MEGA

- 220-240V / 50-60Hz
- Срок службы 25 000 Часов
- 2700K / 6400K

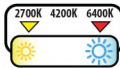

	MEGA-3	MEGA-5
	001-011-0003	001-011-0005

Power	3 W	5 W
Luminous Flux	180 lm	230 lm

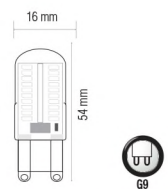

## D I M M A B L E

### NANO

- 220-240V / 50-60Hz
- Срок службы 25 000 Часов
- 2700K / 6400K

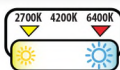

	NANO-2	NANO-3
	001-008-0002	001-008-0003



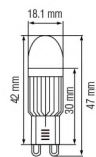
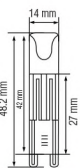

Power	1.5 W	3 W
Luminous Flux	105 lm	210 lm

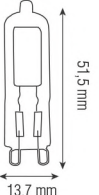

### EXA-3

- 220-240V / 50-60Hz
- Срок службы 25 000 Часов
- 300 lm
- 2700K / 4200K / 6400K





001 047 0003

### GIGA-4

- 220-240V / 50-60Hz
- Срок службы 25 000 Часов
- 360 lm
- 6400K

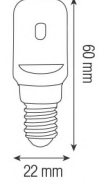
001 046 0004



### MICRO

- 220-240V / 50-60Hz
- Срок службы 25 000 Часов
- 2700K / 6400K

2700K 4200K 6400K







	MICRO-2	MICRO-3
Power	1.5 W	3 W
Luminous Flux	90 lm	150 lm
Sizes (mm)	A: 12 B: 34	A: 12 B: 38

### MINI

- 12V DC
- Срок службы 25 000 Часов
- 60 lm
- 2700K / 6400K

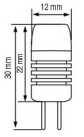
001 009 0002

### MIDI

- 12V DC
- Срок службы 25 000 Часов
- 110 lm
- 2700K / 6400K

001 012 0002







### TERA-2

- 220-240V / 50-60Hz
- Срок службы 25 000 Часов
- 200 lm
- 2700K / 4200K / 6400K

001 024 0002







## D I M M A B L E



### PIKO

- 220-240V / 50-60Hz
- Срок службы 25 000 Часов
- 2700K / 6400K

2700K 4200K 6400K

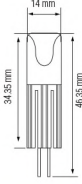

	PIKO-2	PIKO-3
Power	1.5 W	3 W
Luminous Flux	105 lm	210 lm



LED светильники,  
встраиваемые



**BELLA**

016 042 0003



**CHROME**

**MAT CHROME**

**WHITE**

**BLACK**

**ROSE**

- 85-265V / 50-60Hz
- 125 lm
- 4200K
- Срок службы 30 000 Часов

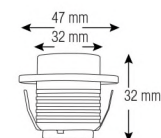

**BIANCA**

016 036 0003



**WHITE**

**MAT CHROME**

- 85-265V / 50-60Hz
- 210 lm
- 4200K
- Срок службы 30 000 Часов

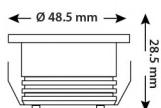

**MIRANDA**

016 004 0003

HL 666L



**CHROME**

**MAT CHROME**

- 220-240V / 50-60Hz
- 260 lm
- 4200K
- Срок службы 30 000 Часов

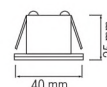

**SILVIA**

016 039 0001



**LAURA**

016 038 0001



**WHITE**

**MAT CHROME**

- 85-265V / 50-60Hz
- 70 lm
- 4200K
- Срок службы 30 000 Часов

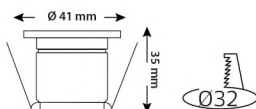
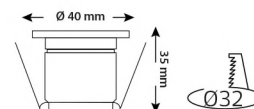



### MONICA

016 003 0001

**CHROME**  
**MAT CHROME**

- 220-240V / 50-60Hz
- 4200K
- 80 lm
- Срок службы 30 000 Часов

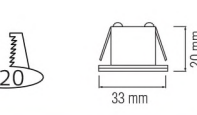
1W POWER LED

3000K 4200K 6400K

Ø20

33 mm

20 mm

### NADIA

016 027 0001

**MAT CHROME**

- 220-240V / 50-60Hz
- 4200K
- 70 lm
- Срок службы 30 000 Часов

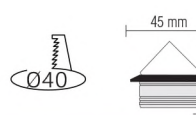
1W POWER LED

3000K 4200K 6400K

Ø40

45 mm

40 mm

### RITA

016 037 0003

**WHITE**

- 85-265V / 50-60Hz
- 210 lm
- 4200K
- Срок службы 30 000 Часов



3W COB LED

3000K 4200K 6400K

Ø35

Ø43 mm

18 mm



### LUNA

016 041 0003

**WHITE**

- 220-220V / 50-60Hz
- 210 lm
- 4200K
- Срок службы 30 000 Часов
- Встраиваемый + накладной
- Простая установка



3W SMD LED

3000K 4200K 6400K

Ø65

70 mm

14.5 mm

### ANGELA

016 002 0002

**MAT CHROME**

- 220-240V / 50-60Hz
- 100 lm
- 4200K
- Срок службы 30 000 Часов



2W SMD LED

3000K 4200K 6400K

Ø51

65 mm

20 mm

### LISA

016 031 0003

**WHITE**

- 220-240V / 50-60Hz
- Срок службы 30 000 Часов
- 125 lm
- 4200K



3W COB LED

3000K 4200K 6400K

Ø35

44 mm

48 mm

### JULIA

016 032 0003

**WHITE**

- 220-240V / 50-60Hz
- Срок службы 30 000 Часов
- 125 lm
- 4200K

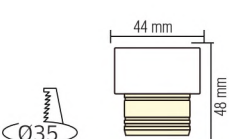
3W COB LED

3000K 4200K 6400K

Ø35

44 mm

48 mm

**GABRIEL**

016 029 0006

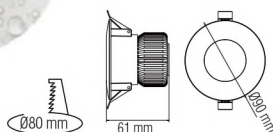
**JESSICA**

016 030 0006

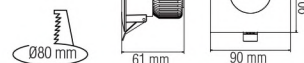
**WHITE**

- 100-240V / 50-60Hz
- Срок службы 30 000 Часов
- 410 lm
- 4200K

**VICTORIA**

- AC 220-240V / 50-60Hz
- Срок службы 30 000 Часов
- 2700K / 4200K / 6400K

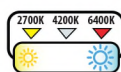

	VICTORIA-3	VICTORIA-5
	016-007-0003	016-007-0005

Power	:	3 W	5 W
Luminous Flux	:	230 lm	300 lm

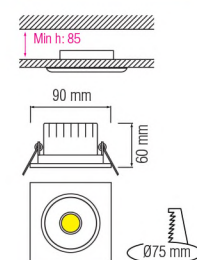
**MAT CHROME****WHITE****MELISA**

- AC 220-240V / 50-60Hz
- Срок службы 30 000 Часов
- 2700K / 4200K / 6400K

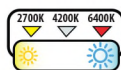

	MELISA-3	MELISA-5
	016-008-0003	016-008-0005

Power	:	3 W	5 W
Luminous Flux	:	230 lm	300 lm

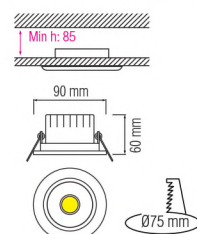
**MAT CHROME****WHITE****LILYA**

- AC 220-240V / 50-60Hz
- Срок службы 30 000 Часов
- 2700K / 4200K / 6400K

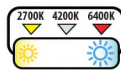

	LILYA-3	LILYA-5
	016-009-0003	016-009-0005

Power	:	3 W	5 W
Luminous Flux	:	222 lm	335 lm

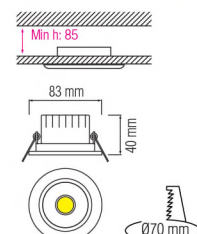
**MAT CHROME****WHITE**

**VALERIA**

- 85-265V / 50-60Hz
- Срок службы 30 000 Часов
- 4200K

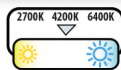
**WHITE**

	VALERIA-5	VALERIA-7	VALERIA-9
	016-040-0005	016-040-0007	016-040-0009

Power	: 5 W	7 W	9 W
Luminous Flux	: 400 lm	560 lm	720 lm
Cutting Diameter (mm)	: Ø50	Ø70	Ø95
Sizes (mm)	: A: 20 B: 62 C: 55	A: 20 B: 82 C: 55	A: 20 B: 102 C: 55

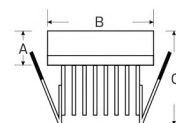
**SONIA-5**

016 035 0005

**WHITE**

- 100-240V / 50-60Hz
- Срок службы 30 000 Часов
- 350 lm
- 6400K

**LILY**

016 018 0030

**WHITE**

- 220-240V / 50-60Hz
- Срок службы 30 000 Часов
- 1447 lm
- 6500K

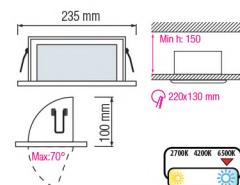
**VERA**

- AC 220-240V / 50-60Hz
- Срок службы 30 000 Часов
- 2700K / 6400K

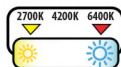
**MAT CHROME**

	VERA-3	VERA-6	VERA-18
	016-011-0003	016-011-0006	016-011-0018

Power	: 3 W	6 W	18 W
Luminous Flux	: 135 lm	270 lm	720 lm
Cutting Diameter (mm)	: Ø70	Ø100	Ø170
Sizes (mm)	: A: 83 B: 40	A: 120 B: 65	A: 192 B: 75

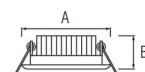
**ELENA**

- AC 220-240V / 50-60Hz
- Срок службы 30 000 Часов
- 2700K / 6400K

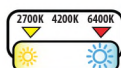
**MAT CHROME**

	ELENA-1	ELENA-3	ELENA-6
	016-010-0001	016-010-0003	016-010-0006

Power	: 1 W	3 W	6 W
Luminous Flux	: 45 lm	135 lm	270 lm
Cutting Diameter (mm)	: Ø50	Ø75	Ø110
Sizes (mm)	: A: 60 B: 20	A: 90 B: 40	A: 120 B: 65

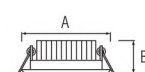

## ADRIANA

- 220-240V / 50-60Hz
- Срок службы 30 000 Часов
- 2700K / 6400K

WHITE

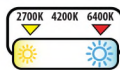

ADRIANA-5	ADRIANA-10	ADRIANA-15
016-021-0005	016-021-0010	016-021-0015

Power	: 5 W	2x5 W	3x5 W
Luminous Flux	: 368 lm	2x368 lm	3x368 lm
Cutting Size (mm)	: 73x73	90x155	90x240
Sizes (mm)	: A: 93 B: 44 C: 93	A: 175 B: 44 C: 93	A: 255 B: 44 C: 93

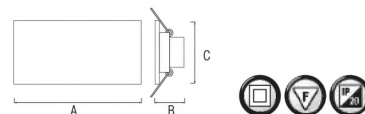

## VERONICA

- 220-240V / 50-60Hz
- Срок службы 30 000 Часов
- 2700K / 6400K

WHITE

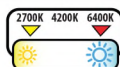

VERONICA-10	VERONICA-20	VERONICA-30
016-022-0010	016-022-0020	016-022-0030

Power	: 10 W	2x10 W	3x10 W
Luminous Flux	: 539 lm	2x539 lm	3x539 lm
Cutting Size (mm)	: 90x90	100x205	100x315
Sizes (mm)	: A: 120 B: 80 C: 120	A: 230 B: 80 C: 120	A: 340 B: 80 C: 120

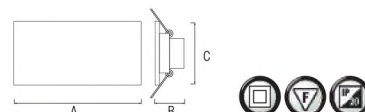

## SABRINA

- 220-240V / 50-60Hz
- Срок службы 30 000 Часов
- 2700K / 6400K

WHITE

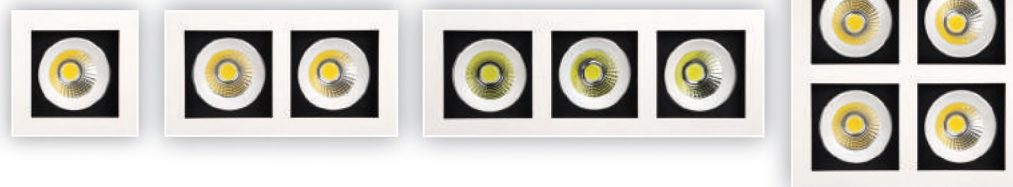
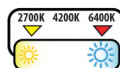

SABRINA-8	SABRINA-16	SABRINA-24	SABRINA-32
016-023-0008	016-023-0016	016-023-0024	016-023-0032

Power	: 8 W	2x8 W	3x8 W	4x8 W
Luminous Flux	: 371 lm	2x371 lm	3x371 lm	4x371 lm
Cutting Size (mm)	: 90x90	81x170	81x255	170x170
Sizes (mm)	: A: 100 B: 67 C: 100	A: 185 B: 67 C: 100	A: 270 B: 67 C: 100	A: 185 B: 67 C: 185

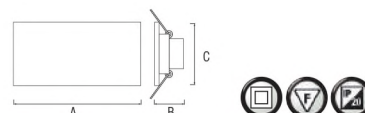

## MARIA

- 220-240V / 50-60Hz
- Срок службы 30 000 Часов
- 3000K/4200K/6400K

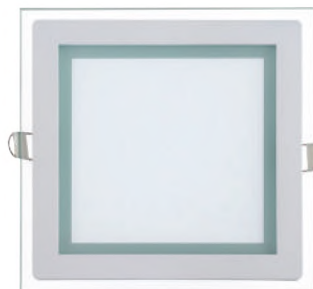
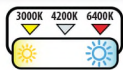

WHITE



MARIA-6	MARIA-12	MARIA-15
016-015-0006	016-015-0012	016-015-0015

Power	: 6 W	12 W	15 W
Luminous Flux	: 600 lm	1200 lm	1500 lm
Cutting Size (mm)	: 73X73	125X125	165X165
Sizes (mm)	: A: 96 B: 35	A: 160 B: 40	A: 198 B: 40

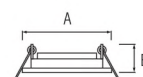

## CLARA

- 220-240V / 50-60Hz
- Срок службы 30 000 Часов
- 3000K/4200K/6400K

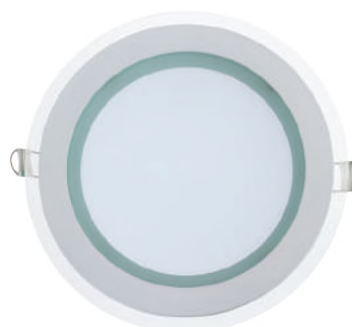
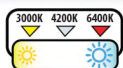

WHITE



CLARA-6	CLARA-12	CLARA-15
016-016-0006	016-016-0012	016-016-0015

Power	: 6 W	12 W	15 W
Luminous Flux	: 600 lm	1200 lm	1500 lm
Cutting Diameter (mm)	: Ø73	Ø125	Ø165
Sizes (mm)	: A: 96 B: 40	A: 160 B: 40	A: 200 B: 40

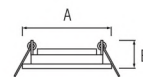

## AMANDA

- 220-240V / 50-60Hz
- Срок службы 30 000 Часов
- 3000K/6400K

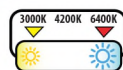

WHITE

MAT CHROME



AMANDA-6	AMANDA-10	AMANDA-15	AMANDA-25
016-017-0006	016-017-0010	016-017-0015	016-017-0025

Power	: 6 W	10 W	15 W	25 W
Luminous Flux	: 600 lm	1000 lm	1500 lm	2500 lm
Cutting Diameter (mm)	: Ø110	Ø137	Ø166	Ø200
Sizes (mm)	: A: 120 B: 42	A: 150 B: 50	A: 180 B: 60	A: 219 B: 70

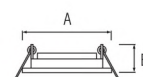

**HOROZ ELECTRIC**

LED светильники, встраиваемые

**LUCIA**

- 85-265V / 50-60Hz
- Срок службы 30 000 Часов
- 6400K

WHITE

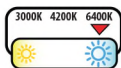
**NEW PRODUCT**

COB LED

	LUCIA-10	LUCIA-15	LUCIA-20	LUCIA-25	LUCIA-30	LUCIA-35	LUCIA-40
	016-046-0010	016-046-0015	016-046-0020	016-046-0025	016-046-0030	016-046-0035	016-046-0040
Power :	10 W	15 W	20 W	25 W	30 W	35 W	40 W
Luminous Flux:	1000 lm	1500 lm	2000 lm	2500 lm	3000 lm	3500 lm	4000 lm
Cutting Diameter:	Ø75	Ø85	Ø95	Ø120	Ø145	Ø165	Ø200
Sizes (mm) :	A: 37 B: 86	A: 44,5 B: 101	A: 53 B: 116	A: 62,6 B: 140	A: 73 B: 163	A: 84 B: 190	A: 99 B: 217

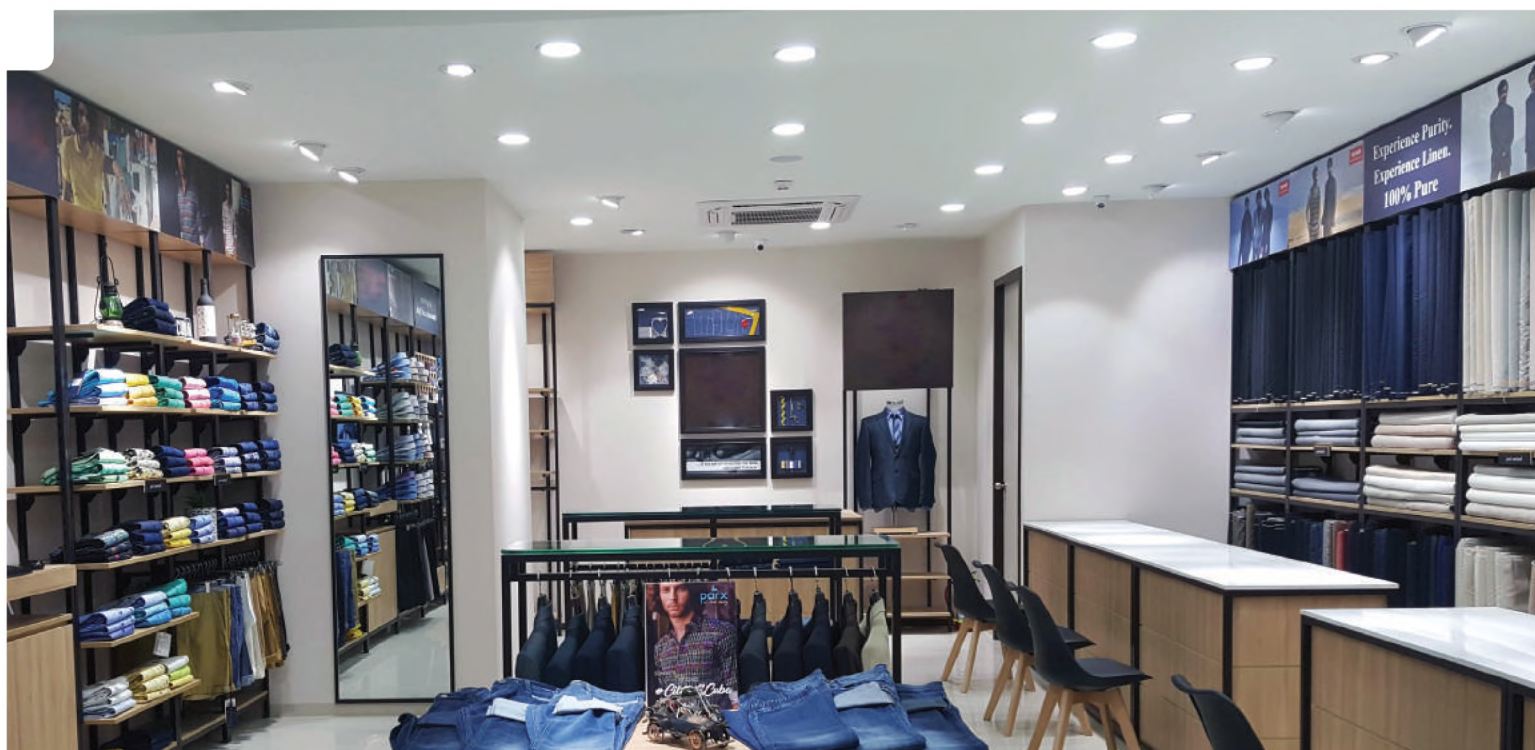
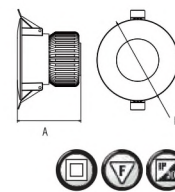

**VANESSA**

- 85-265V / 50-60Hz
- Срок службы 30 000 Часов
- 6400K

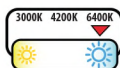
**NEW PRODUCT**

WHITE

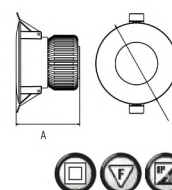

	VANESSA-5	VANESSA-10	VANESSA-15	VANESSA-20	VANESSA-30
	016-044-0005	016-044-0010	016-044-0015	016-044-0020	016-044-0030
Power	: 6 W	: 10 W	: 15 W	: 20 W	: 30 W
Luminous Flux	: 600lm	: 1000 lm	: 1500 lm	: 2000 lm	: 3000lm
Cutting Diameter (mm)	: Ø75	: Ø95	: Ø150	: Ø170	: Ø205
Sizes (mm)	: A: 43 B: 90	: A: 43 B: 120	: A: 43 B: 170	: A: 45 B: 195	: A: 45 B: 225

**ALEXA**

- 160-265V / 50-60Hz
- Срок службы 30 000 Часов
- 6400K

**NEW PRODUCT**

WHITE



	ALEXA-8	ALEXA-12	ALEXA-20	ALEXA-24	ALEXA-30
	016-047-0008	016-047-0012	016-047-0020	016-047-0024	016-047-0030
Power	: 8 W	: 12 W	: 20 W	: 24 W	: 30 W
Luminous Flux	: 960 lm	: 1440 lm	: 2400 lm	: 2880 lm	: 3600 lm
Cutting Diameter (mm)	: Ø75	: Ø95	: Ø115	: Ø145	: Ø190
Sizes (mm)	: A: 32 B: 98	: A: 32 B: 120	: A: 32 B: 145	: A: 32 B: 180	: A: 32 B: 230

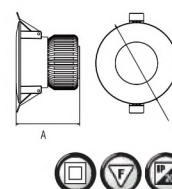



### SANDRA

- 85-265V / 50-60Hz
- Срок службы 30 000 Часов
- 4200K

### SANDRA-XL

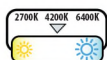

WHITE

BLACK

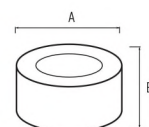

	SANDRA-5	SANDRA-5/XL	SANDRA-10	SANDRA-10/XL	SANDRA-15	SANDRA-15/XL
	016-043-0005	016-043-1005	016-043-0010	016-043-1010	016-043-0015	016-043-1015
Power :	5 W	5 W	10 W	10 W	15 W	15 W
Luminous Flux:	350 lm	350 lm	700 lm	700 lm	1050 lm	1050 lm
Sizes (mm) :	A:105 B:75	A:105 B:162	A:140 B:75	A:140 B:162	A:180 B:75	A:180 B:162

### SANDRA-SQ

- 85-265V / 50-60Hz
- Срок службы 30 000 Часов
- 4200K

### SANDRA-SQ/XL

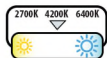

WHITE

BLACK

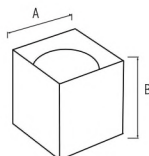

	SANDRA-SQ10	SANDRA-SQ10/XL	SANDRA-SQ15	SANDRA-SQ15/XL
	016-045-0010	016-045-1010	016-045-0015	016-045-1015
Power :	10 W	10 W	15 W	15 W
Luminous Flux:	700 lm	700 lm	1050 lm	1050 lm
Sizes (mm) :	A:136 B:120	A:136 B:200	A:182 B:120	A:182 B:200





## CAROLINE

- 220-240V / 50-60Hz
- Срок службы 30 000 Часов
- 3000K/4200K/6000K

WHITE

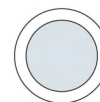
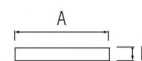
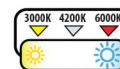

	CAROLINE-12	CAROLINE-18	CAROLINE-28	CAROLINE-32	CAROLINE-40	CAROLINE-48
	016-025-0012	016-025-0018	016-025-0028	016-025-0032	016-025-0040	016-025-0048
Power :	12 W	18 W	28 W	32 W	40 W	48 W
Luminous Flux:	840 lm	1300 lm	1960 lm	2240 lm	2800 lm	3360 lm
Sizes (mm) :	A:160 B:28	A:210 B:28	A:287 B:28	A:400 B:40	A:500 B:40	A:600 B:40

## ARINA

- 220-240V / 50-60Hz
- Срок службы 30 000 Часов
- 3000K/4200K/6000K

WHITE

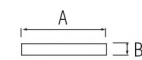
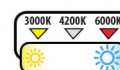

	ARINA-12	ARINA-18	ARINA-28	ARINA-32	ARINA-40	ARINA-48
	016-026-0012	016-026-0018	016-026-0028	016-026-0032	016-026-0040	016-026-0048
Power :	12 W	18 W	28 W	32 W	40 W	48 W
Luminous Flux:	840 lm	1300 lm	1960 lm	2240 lm	2800 lm	3360 lm
Sizes (mm) :	A:159.5 B:28	A:211 B:28	A:283 B:28	A:400 B:40	A:500 B:40	A:600 B:40

## LINDA

- 220-240V / 50-60Hz
- Срок службы 30 000 Часов
- 3000K/4200K/6000K

WHITE

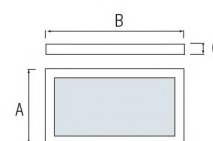
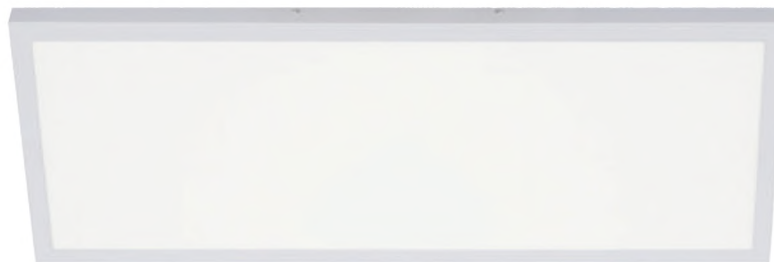
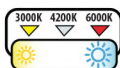

	LINDA-24	LINDA-36
	016-034-0024	016-034-0036
Power :	24 W	36 W
Luminous Flux :	1680 lm	2520 lm
Sizes (mm) :	A: 300 B: 600 C: 40	A: 300 B: 1200 C: 40

**HOROZ ELECTRIC**

LED панели, встраиваемые

**SLIM**

- 220-240V / 50-60Hz
- Срок службы 30 000 Часов
- 2700K / 4200K / 6400K

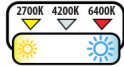

	SLIM-3	SLIM-6	SLIM-9	SLIM-12	SLIM-15	SLIM-18	SLIM-24
	056-003-0003	056-003-0006	056-003-0009	056-003-0012	056-003-0015	056-003-0018	056-003-0024
Power :	3 W	6 W	9 W	12 W	15 W	18 W	24 W
Luminous Flux:	300 lm	600 lm	900 lm	1200 lm	1500 lm	1800 lm	2400 lm
Cutting Diameter :	Ø70	Ø108	Ø132	Ø155	Ø176	Ø215	Ø279
Sizes (mm) :	A:14 B:83	A:14 B:118,5	A:14 B:146	A:14 B:168	A:17 B:190	A:14 B:221	A:14,5 B:297

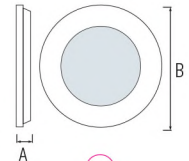
**HOROZ ELECTRIC**LED панели,  
встраиваемые**SLIM/Sq**

- 220-240V / 50-60Hz
- Срок службы 30 000 Часов
- 2700K / 4200K / 6400K

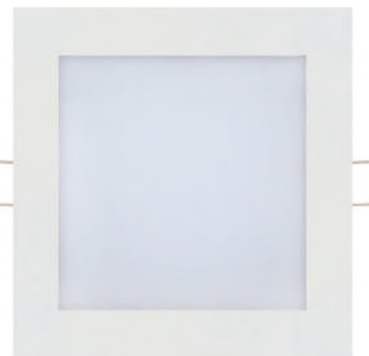
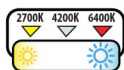

	SLIM / Sq-3	SLIM / Sq-6	SLIM / Sq-9	SLIM / Sq-12	SLIM / Sq-15	SLIM / Sq-18	SLIM / Sq-24
	056-005-0003	056-005-0006	056-005-0009	056-005-0012	056-005-0015	056-005-0018	056-005-0024
Power :	3 W	6 W	9 W	12 W	15 W	18 W	24 W
Luminous Flux:	300 lm	600 lm	900 lm	1200 lm	1500 lm	1800 lm	2400 lm
Cutting Size (mm) :	76x76	105x105	135x135	156x156	178x178	207x207	282x282
Sizes (mm) :	A:16 B:89	A:18 B:113,5	A:16 B:146	A:18 B:163	A:15 B:194,5	A:18 B:219,5	A:17 B:296

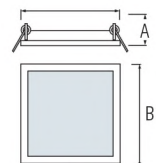

**GALAKSI-45**

056 002 0045

**WHITE**

- 220-240V / 50-60Hz
- 45W, 3150 lm
- 4200K / 6400K
- Срок службы 25 000 Часов

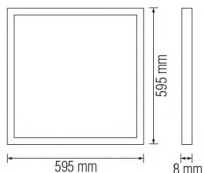
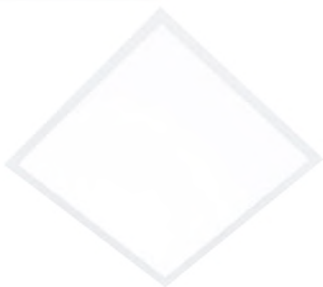
**STAR-50**

056 001 0050

**SILVER**

- 220-240V / 50-60Hz
- 50W, 4200 lm
- 4200K / 6400K
- Срок службы 25 000 Часов

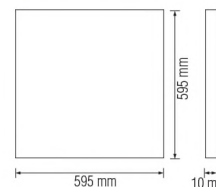
**MOON**

- 220-240V / 50-60Hz
- Срок службы 25 000 Часов
- 4200K / 6400K

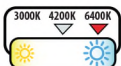
**MOON-32****MOON-40**

056-007-0032

056-007-0040

Power	:	<b>32 W</b>	<b>40 W</b>
Luminous Flux	:	2240 lm	2800 lm
Sizes (mm)	:	A: 400 B: 400 C: 8	A: 500 B: 500 C: 8

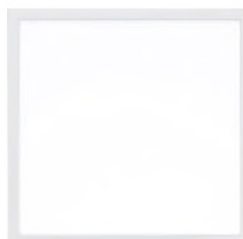
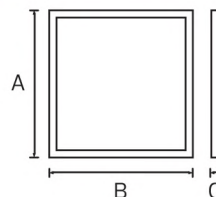
**NEW PRODUCT****WHITE****ZODIAC**

- 220-240V / 50-60Hz
- Срок службы 25 000 Часов
- 4200K / 6400K

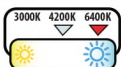
**ZODIAC-24****ZODIAC-36**

056-006-0024

056-006-0036

Power	:	<b>24 W</b>	<b>36 W</b>
Luminous Flux	:	1680 lm	2520 lm
Sizes (mm)	:	A: 295 B: 595 C: 8	A: 295 B: 1195 C: 8

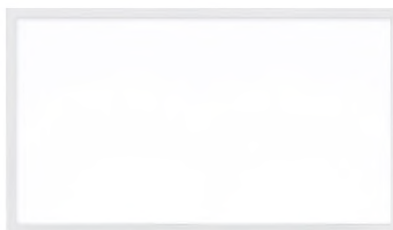
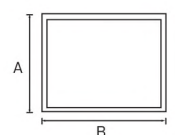
**NEW PRODUCT****WHITE****FRAME****WHITE****DRY KIT**

111 001 0001

- Крепёжная рамка
- Для LED панелей

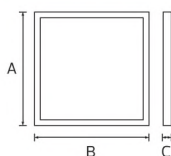
**FRAME-3060****FRAME-30120****FRAME-4040****FRAME-5050****FRAME-6060**

111-002-0001

111-002-0002

111-002-0003

111-002-0004

111-002-0005

Sizes (mm):	A: 600 B: 300 C: 45	A: 1200 B: 300 C: 45	A: 400 B: 400 C: 45	A: 500 B: 500 C: 45	A: 600 B: 600 C: 45
-------------	---------------------	----------------------	---------------------	---------------------	---------------------

**NEW PRODUCT**

**HOROSZ ELECTRIC**

## LED системы трекового освещения

Z O O M A B L E

**MONACO**

- 100-240V / 50-60Hz
- Срок службы 40 000 Часов
- 4200K
- Угол освещения: 15°-60°

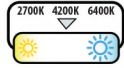
**NEW PRODUCT**

WHITE

BLACK



MONACO-15	MONACO-30
018-019-0015	018-019-0030

Power	: 15 W	30 W
Luminous Flux	: 1125 lm	2250 lm
Sizes (mm)	: A: 150 B: 130 C: 140 D: 47 E: 59	A: 190 B: 170 C: 165 D: 64 E: 85

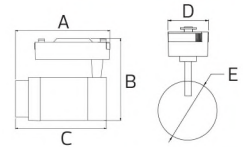
**HOROSZ ELECTRIC**

## LED системы трекового освещения

**LYON**

- 100-240V / 50-60Hz
- Срок службы 40 000 Часов
- 4200K
- Угол освещения: 24°

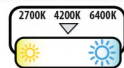
**NEW PRODUCT**

WHITE

BLACK



LYON-10	LYON-18	LYON-24
018-020-0010	018-020-0018	018-020-0024

Power	: 10 W	18 W	24 W
Luminous Flux	: 650 lm	1170 lm	1560 lm
Sizes (mm)	: A: 81 B: 140 C: 102 D: 37 E: 68	A: 170 B: 162 C: 110 D: 61 E: 84	A: 200 B: 190 C: 140 D: 66 E: 89

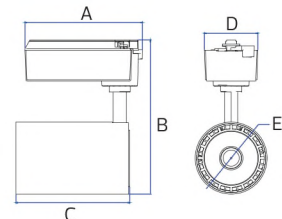
**BERN**

018 017 0030

**NEW PRODUCT**WHITE  
BLACK

- 180-240V / 50-60Hz
- Срок службы 30 000 Часов
- 2000 lm
- 4200K
- Угол освещения: 21°

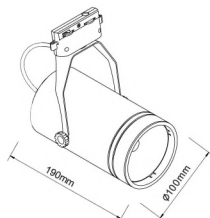
**DUBLIN**

018 018 0035

**NEW PRODUCT**WHITE  
BLACK

- 180-240V / 50-60Hz
- Срок службы 30 000 Часов
- 3400 lm
- 4200K
- Срок службы 30 000 Часов

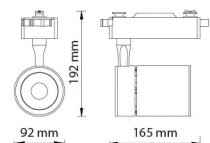



**HOROZ ELECTRIC**

LED системы трекового освещения

Z O O M A B L E

**PORTO**

018 013 0007

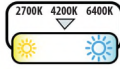

WHITE

BLACK

SILVER

- 100-240V / 50-60Hz
- Срок службы 40 000 Часов
- 525 lm
- 4200K
- Угол освещения: 18°-70°

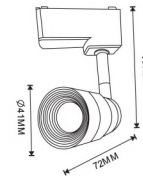
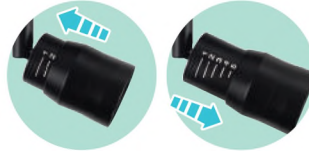

**OSLO**

018 012 0010



WHITE

BLACK

SILVER

- 100-240V / 50-60Hz
- Срок службы 40 000 Часов
- 900 lm
- 4200K
- Угол освещения: 21°

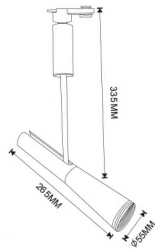

**ROMA**

018 002 0023



WHITE

BLACK

SILVER

- 220-240V / 50-60Hz
- Срок службы 40 000 Часов
- 1315 lm
- 4200K
- Угол освещения: 60°

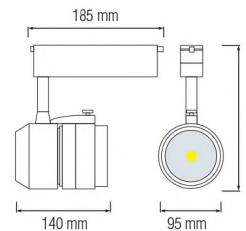

**ZAGREB**

018 009 0035



WHITE

BLACK

SILVER

- 100-240V / 50-60Hz
- Срок службы 40 000 Часов
- 2078 lm
- 4200K
- Угол освещения: 20°

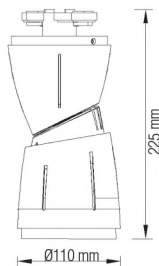

**PARIS**

- 220-240V / 50-60Hz
- Срок службы 40 000 Часов
- 4200K
- Угол освещения: 24°

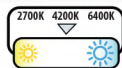
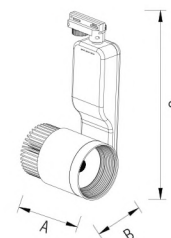
**WHITE****BLACK****SILVER**

PARIS-23	PARIS-33
018-007-0023	018-007-0033

Power	:	<b>23 W</b>	<b>33 W</b>
Luminous Flux	:	1550 lm	2256 lm
Sizes (mm)	:	A: 110 B: 110 C: 280	A: 128 B: 124 C: 290

**ZURIH**

- 220-240V / 50-60Hz
- Срок службы 40 000 Часов
- 4200K
- Угол освещения: 24°

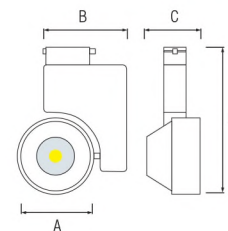
**WHITE****BLACK****SILVER**

ZURIH-23	ZURIH-40
018-001-0023	018-001-0040

Power	:	<b>23 W</b>	<b>40 W</b>
Luminous Flux	:	1511 lm	2643 lm
Sizes (mm)	:	A: 110 B: 120 C: 65 D: 210	A: 120 B: 156 C: 68 D: 223

**PRAG**

- 220-240V / 50-60Hz
- Срок службы 40 000 Часов
- 4200K

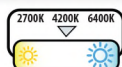
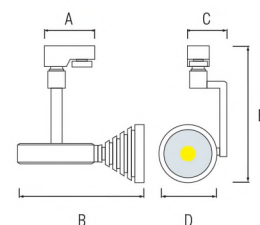
**WHITE****BLACK****SILVER**

PRAG-7	PRAG-12
018-003-0007	018-003-0012

Power	:	<b>7 W</b>	<b>12 W</b>
Luminous Flux	:	405 lm	852 lm
Beam Angle	:	37°	32°
Sizes (mm)	:	A: 65 B: 170 C: 88 D: 90 E: 265	A: 65 B: 175 C: 85 D: 110 E: 278



**HOROZ ELECTRIC**

LED системы трекового освещения

**TORINO**

- 220-240V / 50-60Hz
- Срок службы 40 000 Часов
- 4200K
- Угол освещения: 24°

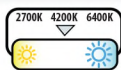

- WHITE
- BLACK
- SILVER

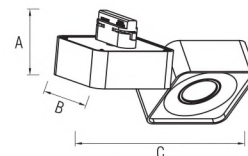

TORINO-23	TORINO-40
018-004-0023	018-004-0040

Power	:	23 W	40 W
Luminous Flux	:	1560 lm	2337 lm
Sizes (mm)	:	A: 89 B: 120 C: 241	A: 112.5 B: 120 C: 241

**MADRID**

- 220-240V / 50-60Hz
- Срок службы 40 000 Часов
- 4200K
- Угол освещения: 24°

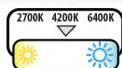

- WHITE
- BLACK
- SILVER

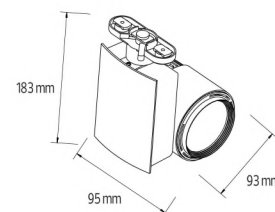

MADRID-23	MADRID-40
018-005-0023	018-005-0040

Power	:	23 W	40 W
Luminous Flux	:	1779 lm	2988 lm

**VENEDIK**

- 220-240V / 50-60Hz
- Срок службы 40 000 Часов
- 4200K
- Угол освещения: 24°

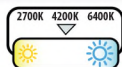

- WHITE
- BLACK
- SILVER

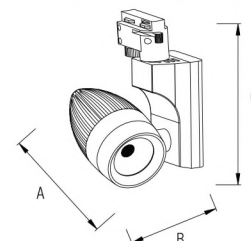

VENEDIK-23	VENEDIK-33
018-006-0023	018-006-0033

Power	:	23 W	33 W
Luminous Flux	:	1947 lm	2142 lm
Sizes (mm)	:	A: 120 B: 140 C: 175	A: 175 B: 140 C: 185





**HOROZ ELECTRIC**

LED системы трекового освещения

**MILANO**

- 220-240V / 50-60Hz
- Срок службы 40 000 Часов
- 4200K

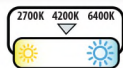

- WHITE**
- BLACK**
- SILVER**



	MILANO-5	MILANO-8	MILANO-13
	018-008-0005	018-008-0008	018-008-0013

Power	: 5 W	8 W	13 W
Luminous Flux	: 334 lm	600 lm	987 lm
Beam Angle	: 55°	53°	73°
Sizes (mm)	: A: 40 B: 70 C: 128	A: 48 B: 95 C: 132	A: 60 B: 108 C: 145

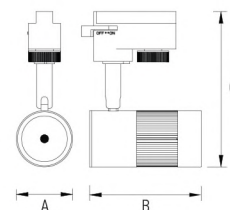

**HOROZ ELECTRIC**

LED системы трекового освещения



**BEYRUT**

017 001 0005



- WHITE**
- BLACK**

- 220-240V / 50-60Hz
- Срок службы 40 000 Часов
- 320 lm
- 4200K
- Угол освещения: 60°

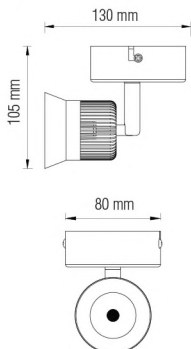

**TOKYO**

017 002 0008



- WHITE**
- BLACK**

- 100-240V / 50-60Hz
- Срок службы 40 000 Часов
- 500 lm
- 4200K
- Угол освещения: 53°

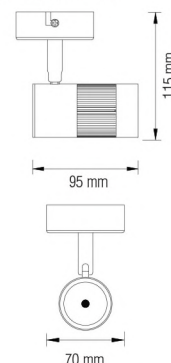





**HOROZ ELECTRIC**

# LED системы трекового освещения

### СОЕДИНИТЕЛИ

- Однофазный
- 220-240V / 50-60Hz AC
- Max. 16A

WHITE

BLACK

SILVER

096 001 0001

Прямой коннектор



Угловой коннектор



096 002 0002

### ВСТРАИВАЕМЫЙ ШИНОПРОВОД

098 001 0001

WHITE

BLACK

SILVER

- 220-240V / 50-60Hz
- Max. 16A

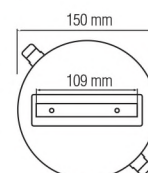

125



### ШИНОПРОВОД

1m, 2m, 3m

WHITE

BLACK

SILVER

- 220-240V / 50-60Hz
- Max. 16A

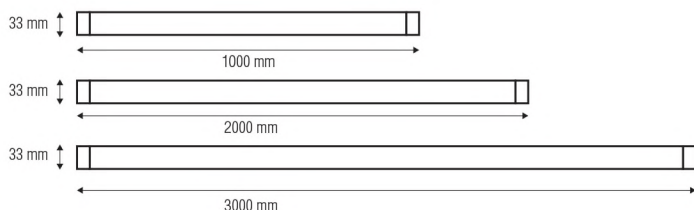
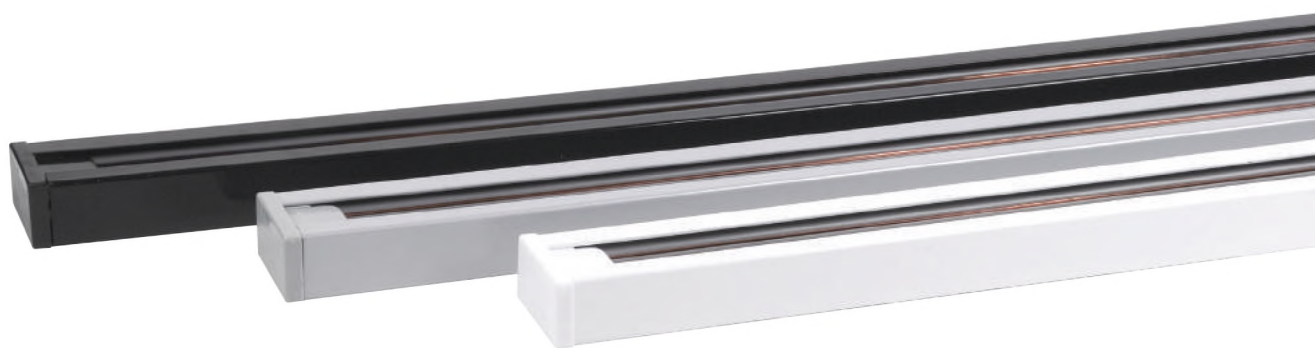

1m. 097 001 0001

2m. 097 001 0002

3m. 097 001 0003



**HOROZ ELECTRIC**

LED Подвесные светильники

**PRIME-45**

019 029 0045



**NEW PRODUCT**



**CHROME**

- 110-240V / 50-60Hz
- Срок службы 30 000 Часов
- 3500 lm
- 4000K

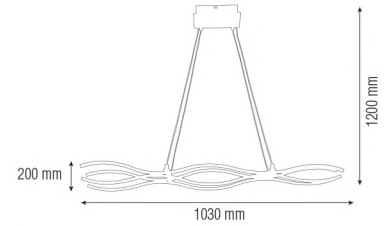

**HOROZ ELECTRIC**

LED Подвесные  
светильники



**OPTIMA-6**

019 030 0006

**NEW PRODUCT**



**OPTIMA-12**

019 030 0012



**OPTIMA-18**

019 030 0018



**CHROME**

- 110-240V / 50-60Hz
- Срок службы 30 000 Часов
- 450 lm / 900 lm / 1350 lm
- 4000K

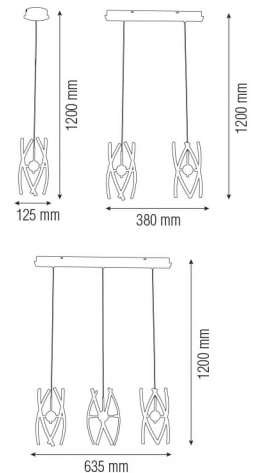

## CALIBUR-24

019 031 0024

**NEW  
PRODUCT**



**CHROME**

- 110-240V / 50-60Hz
- Срок службы 30 000 Часов
- 1800 lm
- 4000K

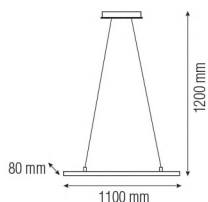

## CAMEL-40

019 032 0040

**NEW  
PRODUCT**



**CHROME**

- 110-240V / 50-60Hz
- Срок службы 30 000 Часов
- 3000 lm
- 4000K

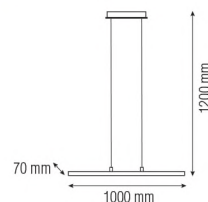

## COSTA-35

019 015 0035

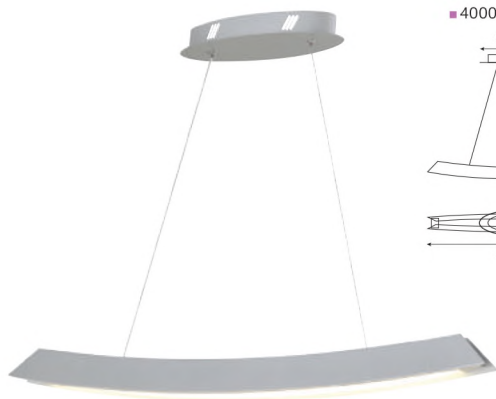

**BLACK**

**WHITE**

- 220-240V / 50-60Hz
- Срок службы 50 000 Часов
- 2000 lm
- 4000K

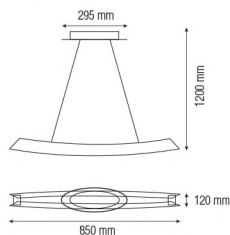

## MATRIX-35

019 013 0035



**BLACK**

**WHITE**

- 220-240V / 50-60Hz
- Срок службы 50 000 Часов
- 2000 lm
- 4000K

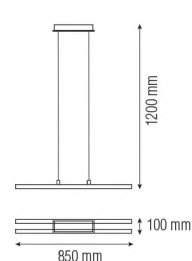

**PHOENIX**

019 020 0038

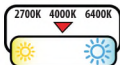

**CHROME**

**RED COPPER**

- 110-240V / 50-60Hz
- Срок службы 30 000 Часов
- 2623lm
- 4000K

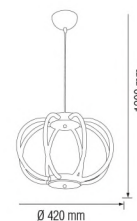

**ELECTRA**

019 021 0038

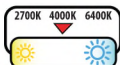

**CHROME**

**RED COPPER**

- 110-240V / 50-60Hz
- Срок службы 30 000 Часов
- 2548lm
- 4000K

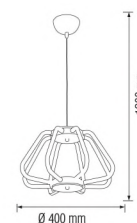

## ORIENT

019 016 0016



### CHROME

- 110-240V / 50-60Hz
- Срок службы 30 000 Часов
- 1211lm
- 4000K

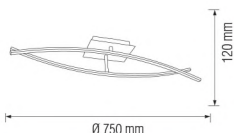

## ORION

019 017 0030



### CHROME

- 110-240V / 50-60Hz
- Срок службы 30 000 Часов
- 2059lm
- 4000K

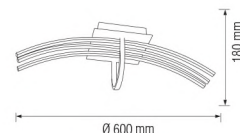

## AVALON

019 018 0035



### CHROME

- 110-240V / 50-60Hz
- Срок службы 30 000 Часов
- 2100lm
- 4000K

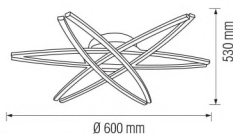

## GLORY

019 019 0045



### CHROME

- 110-240V / 50-60Hz
- Срок службы 30 000 Часов
- 3964lm
- 4000K

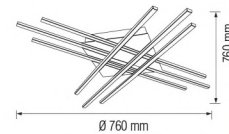

## NEBULA

019 026 0040

CHROME

- 180-260V / 50-60Hz
- Срок службы 30 000 Часов
- 1200 lm
- 4000K

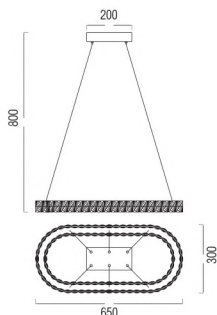

## POLARIS

019 024 0046

CHROME

- 180-260V / 50-60Hz
- Срок службы 30 000 Часов
- 1380 lm
- 4000K

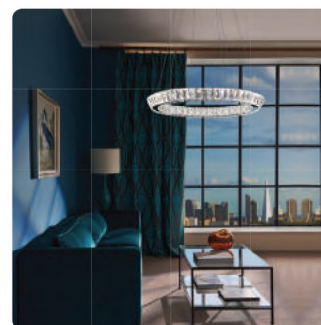
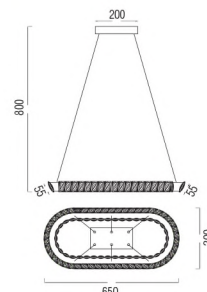
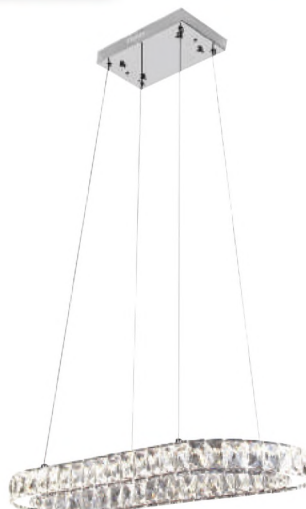

## TORNADO

- 180-260V / 50-60Hz
- Срок службы 30 000 Часов
- 4000K

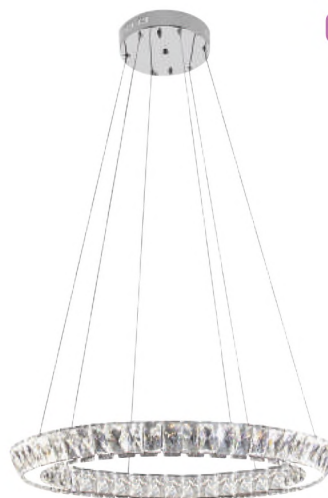
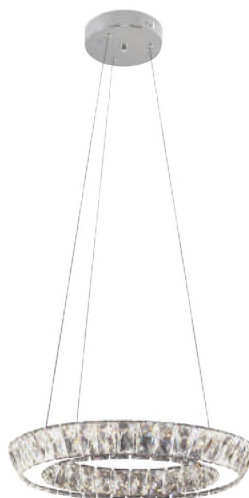
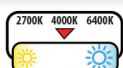

CHROME

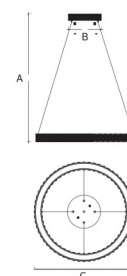

TORNADO-30

TORNADO-40

019-025-0030

019-025-0040

Power	:	30 W	40 W
Luminous Flux	:	900 lm	1200 lm
Sizes (mm)	:	A: 800 B: 150 C: 400	A: 800 B: 200 C: 600



**ETERNITY**

- 180-260V / 50-60Hz
- Срок службы 30 000 Часов
- 4000K

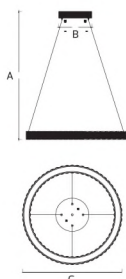
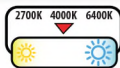

ETERNITY-30	ETERNITY-40
019-022-0030	019-022-0040

Power	: 30 W	40 W
Luminous Flux	: 900 lm	1200 lm
Sizes (mm)	: A: 800 B: 150 C: 400	A: 800 B: 200 C: 600

CHROME

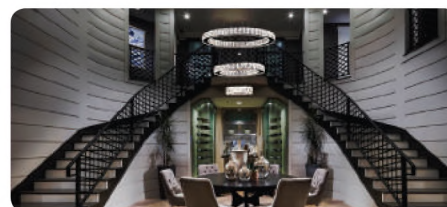

**QUASAR**

- 180-260V / 50-60Hz
- Срок службы 30 000 Часов
- 4000K

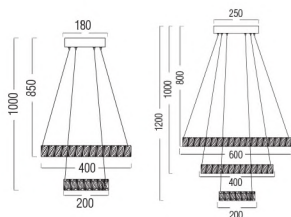
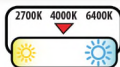

QUASAR-42	QUASAR-90
019-023-0042	019-023-0090

Power	: 42 W	90 W
Luminous Flux	: 1260 lm	2700 lm

CHROME



**NIRVANA**

- 180-260V / 50-60Hz
- Срок службы 30 000 Часов
- 4000K

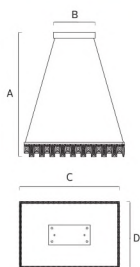
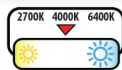

CHROME



NIRVANA-24	NIRVANA-32	NIRVANA-40
019-027-0024	019-027-0032	019-027-0040

Power	: 24 W	32 W	40 W
Luminous Flux	: 720 lm	960 lm	1200 lm
Sizes (mm)	: A: 800 B: 200 C: 400 D: 200	A: 1000 B: 200 C: 500 D: 300	A: 1000 B: 250 C: 600 D: 400

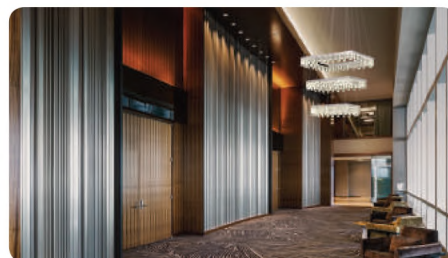
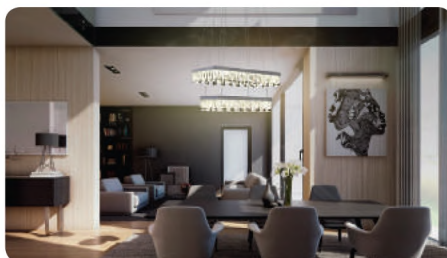
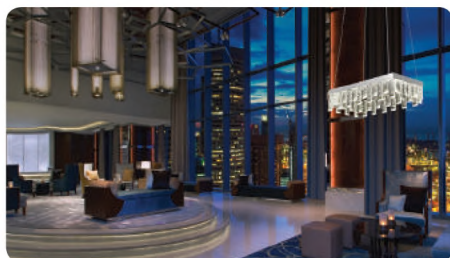

**PANDORA**

- 180-260V / 50-60Hz
- Срок службы 30 000 Часов
- 4000K

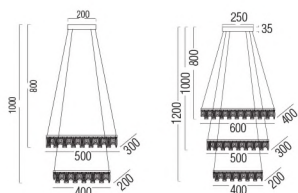
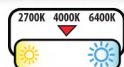

CHROME



PANDORA-72	PANDORA-96
019-028-0072	019-028-0096

Power	: 72 W	96 W
Luminous Flux	: 2160 lm	2880 lm





**DELUXE**

- 220-240V / 50-60Hz
- Срок службы 50 000 Часов
- 4000K

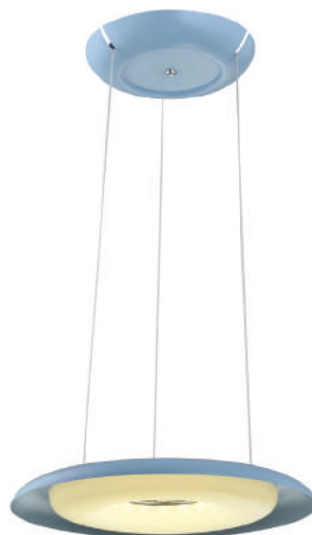
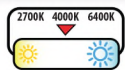

BLACK

WHITE

RED

BLUE



DELUXE-35	DELUXE-70
019-012-0035	019-012-0070

Power	: 35 W	70 W
Luminous Flux	: 2000 lm	3900 lm
Sizes (mm)	: A: 1200 B: 250 C: 420	A: 1200 B: 250 C: 580

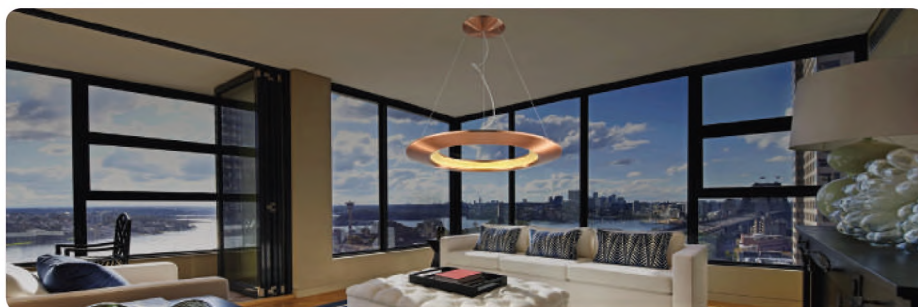
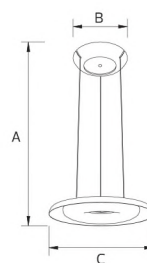

**CONCEPT**

- 220-240V / 50-60Hz
- Срок службы 50 000 Часов

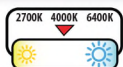

ROSE

CHROME

WHITE



CONCEPT-35	CONCEPT-41
019-010-0035	019-010-0041

Power	: 35 W	41 W
Luminous Flux	: 1000 lm	1500 lm
Sizes (mm)	: A: 200 B: 65 C:1200 D: 45 E: 461	A: 200 B: 65 C:1200 D: 45 E: 648

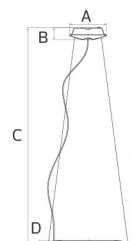

**ROYAL**

- 220-240V / 50-60Hz
- Срок службы 50 000 Часов
- 4000K

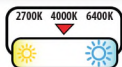

ROYAL-18	ROYAL-24
019-001-0018	019-001-0024

Power	: 18 W	24 W
Luminous Flux	: 1260 lm	1680 lm
Sizes (mm)	: A: 1000 B: 160 C: 454	A: 1000 B: 180 C: 604



WHITE

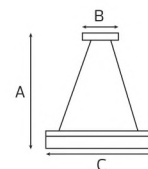

**CLASIS**

- 220-240V / 50-60Hz
- Срок службы 50 000 Часов
- 4000K

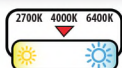

CLASIS-21	CLASIS-31	CLASIS-42
019-002-0021	019-002-0031	019-002-0042

Power	: 21 W	31 W	42 W
Luminous Flux	: 1470 lm	2170 lm	2940 lm
Sizes (mm)	: A: 1000 B: 160 C: 418	A: 1000 B: 180 C: 620	A: 1000 B: 180 C: 818



WHITE

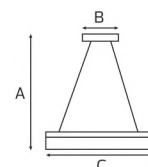

**MASTER**

- 220-240V / 50-60Hz
- Срок службы 50 000 Часов
- 4000K

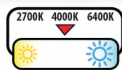

WHITE



MASTER-42      MASTER-75

019-003-0042      019-003-0075

Power	: 42 W	75 W
Luminous Flux	: 2940 lm	5250 lm
Sizes (mm)	: A: 1350 B: 504	A: 1500 B: 804

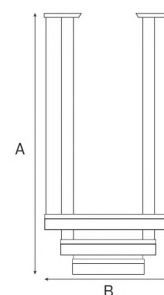

**EXCLUSIVE**

- 220-240V / 50-60Hz
- Срок службы 50 000 Часов
- 4000K

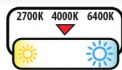

WHITE



EXCLUSIVE-24      EXCLUSIVE-40

019-004-0024      019-004-0040

Power	: 24 W	40 W
Luminous Flux	: 1680 lm	2800 lm

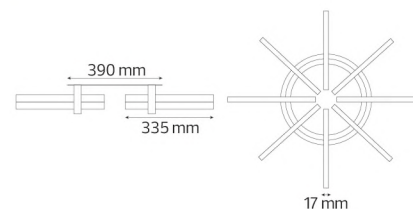

**AVANGARD**

- 220-240V / 50-60Hz
- Срок службы 50 000 Часов
- 4000K

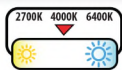

- WHITE
- BLACK

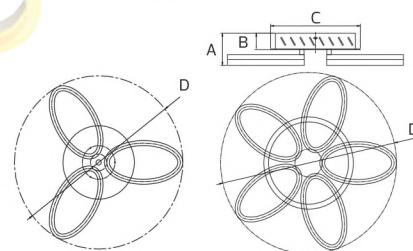
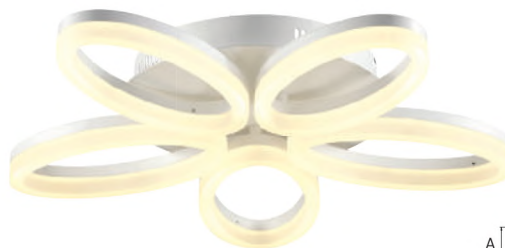

AVANGARD-24	AVANGARD-40
019-005-0024	019-005-0040

Power	: 24 W	40 W
Luminous Flux	: 1680 lm	2800 lm
Sizes (mm)	: A: 82,36 B: 42 C: 230 D: 515	A: 98 B: 50 C: 280 D: 550

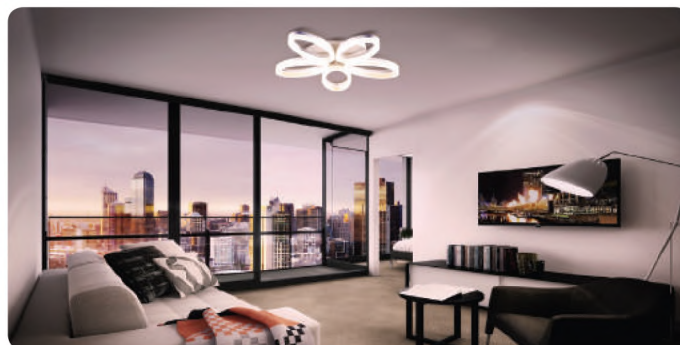
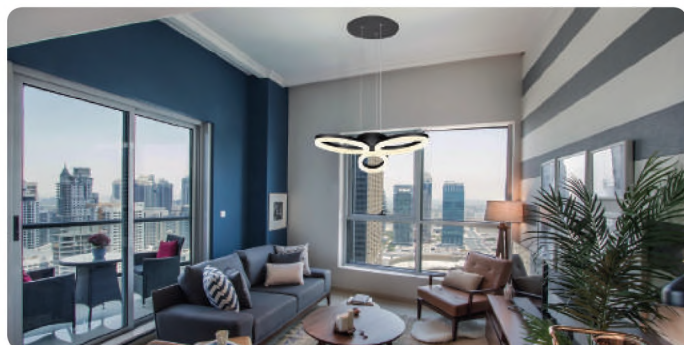

**ELEGANCE**

- 220-240V / 50-60Hz
- Срок службы 50 000 Часов
- 4000K

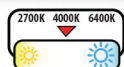

- WHITE
- BLACK

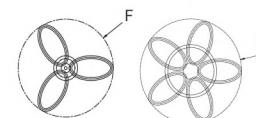
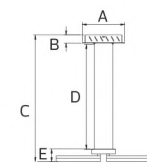

ELEGANCE-24	ELEGANCE-40
019-006-0024	019-006-0040

Power	: 24 W	40 W
Luminous Flux	: 1680 lm	2800 lm
Sizes (mm)	: A: 230 B: 42 C: 1319 D: 1200 E: 66,6 F: 515	A: 230 B: 42 C: 1319 D: 1200 E: 66,6 F: 550

**TREND**

- 220-240V / 50-60Hz
- Срок службы 50 000 Часов
- 4000K

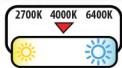

**BLACK**

**WHITE**



	TREND-50	TREND-85
	019-009-0050	019-009-0085
Power	50 W	85 W
Luminous Flux	800 lm	1400 lm
Sizes (mm)	A: 190 B: 95 C: 550 D: 550	A: 270 B: 105 C: 790 D: 790

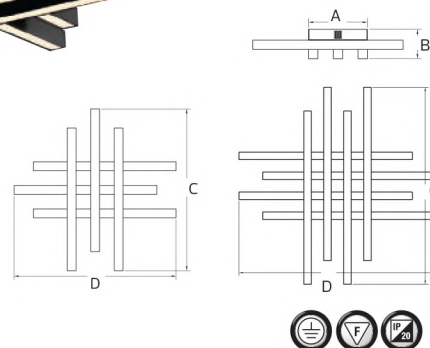

**ASFOR**

- 220-240V / 50-60Hz
- Срок службы 50 000 Часов
- 4000K



**BLACK**

**WHITE**

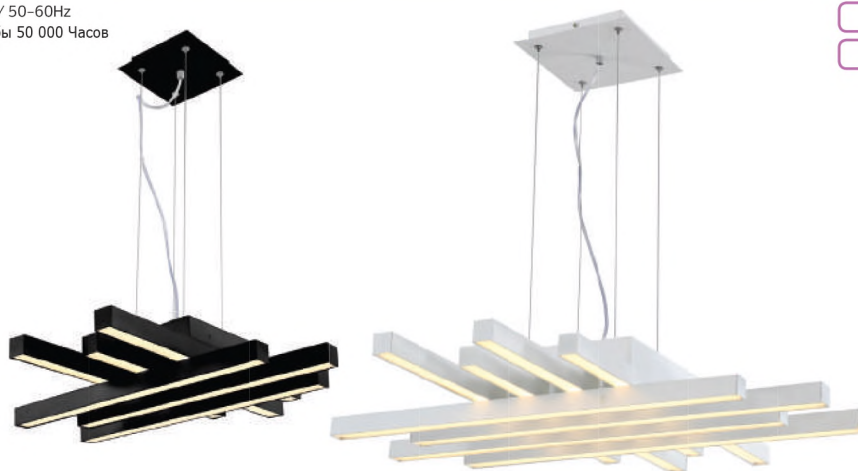

	ASFOR-50	ASFOR-85
	019-011-0050	019-011-0085
Power	50 W	85 W
Luminous Flux	800 lm	1400 lm
Sizes (mm)	A: 160 B: 26 C: 1200 D: 95 E: 550 F: 550	A: 210 B: 26 C: 1200 D: 105 E: 790 F: 790

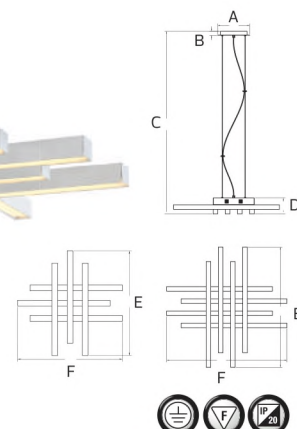



**HOROZ ELECTRIC**

LED Люстры / LED подвесы

**VISTA**

WHITE

BLACK

RED

019 007 0024

- 220-240V / 50-60Hz
- Срок службы 50 000 Часов
- 1500 lm
- 4000K

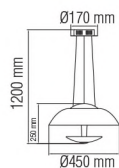

**FAVORI**

CHROME

COPPER

BROWN

019 008 0062

- 220-240V / 50-60Hz
- Срок службы 50 000 Часов
- 2500 lm
- 4000K

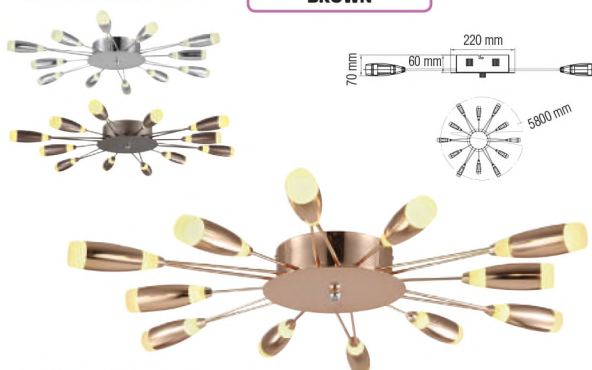

**HOROZ ELECTRIC**

LED Подвесы



**SEMBOL**

020 006 0012

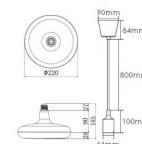

BLACK

WHITE

RED

GREEN

YELLOW

BLUE

- 220-240V / 50-60Hz
- Срок службы 30 000 Часов
- 850 lm
- 4000K

**NOVA**

020 003 0006



- BLACK
- WHITE
- PINK
- PURPLE
- ORANGE
- BLUE

- 220-240V / 50-60Hz
- Срок службы 30 000 Часов
- 300 lm
- 4200K



**PRIZMA**

020 007 0006



BLACK

WHITE

PINK

PURPLE

ORANGE

BLUE

- 220-240V / 50-60Hz
- Срок службы 30 000 Часов
- 350 lm
- 4000K

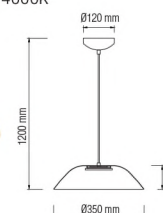



**HOROZ ELECTRIC**

Декоративные подвесы

**WEBER**

021 008 0001



RED COPPER

OLD BRONZE

GOLD

CHROME

PEARL BLACK

■ 250V~/4A  
■ Max. 60W



**GAUSS**

021 009 0001



RED COPPER

OLD BRONZE

GOLD

CHROME

PEARL BLACK

■ 250V~/4A  
■ Max. 60W

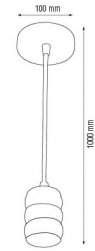

**HOROZ ELECTRIC**

Декоративные подвесы



**EDISON**

021 002 0001



RED COPPER

OLD BRONZE

GOLD

CHROME

PEARL BLACK

■ 250V~/4A  
■ Max. 60W



**VOLTA**

021 001 0001



BLACK

WHITE

BROWN

BLUE

RED

GREY

■ 250V~/4A  
■ Max. 60W

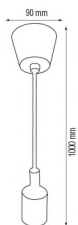

**TESLA**

021 003 0001



RED COPPER

OLD BRONZE

GOLD

CHROME

PEARL BLACK

■ 250V~/4A  
■ Max. 60W

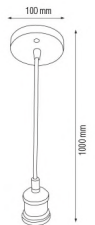



**HOROZ ELECTRIC**

## Декоративные подвесы

### KEPLER

021 011 0001

СКЛАДНОЙ



BLACK

- 250V~/4A
- Max. 60W

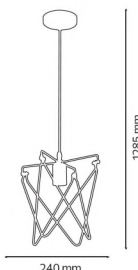

E27

### MAXWELL

021 012 0001

СКЛАДНОЙ



BLACK

- 250V~/4A
- Max. 60W

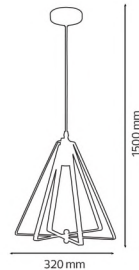

E27



### NEWTON

021 010 0001

СКЛАДНОЙ



BLACK

- 250V~/4A
- Max. 60W



E27

### NOBEL

021 013 0001

СКЛАДНОЙ



BLACK

- 250V~/4A
- Max. 60W

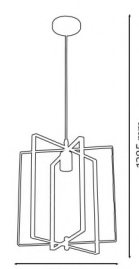

E27





**HOROZ ELECTRIC**

Декоративные подвесы

**LASER**

021 004 0001



021 004 0002

**CHROME**

- 250V~/4A
- Max. 60W
- Glass

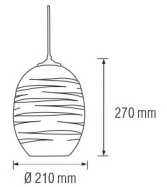
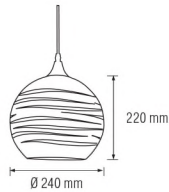

**SPECTRUM**

021 005 0001



021 005 0002

**CHROME**

- 250V~/4A
- Max. 60W
- Glass

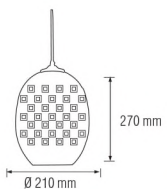
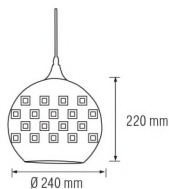

**RADIAN**

021 007 0001



021 007 0002

**CHROME**

- 250V~/4A
- Max. 60W
- Glass

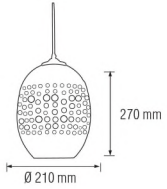
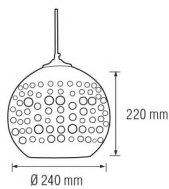

**QUANTUM**

021 006 0001



021 006 0002

**COPPER**

**CHROME**

- 250V~/4A
- Max. 60W
- Glass

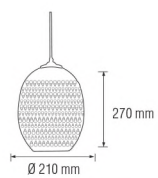
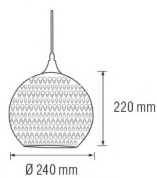



**HOROSZ ELECTRIC**

Декоративные подвесы / Гирлянды

**METEOR**

021 014 0001 021 014 0002

**NEW PRODUCT**

**COPPER**

**CHROME**

- 240V ~ / 4A
- Max. 60W
- Glass

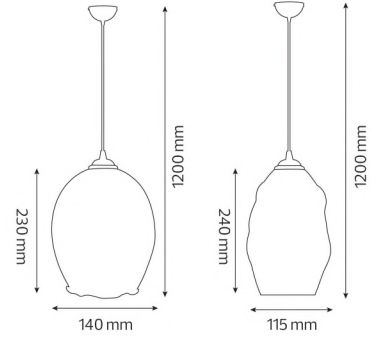

**HOROSZ ELECTRIC**

Гирлянды



**CARNAVAL**

- 220V~
- На 10 ламп (Max мощность 60W)
- 10 метров
- Соединяемые
- Лампы в комплект не входят

**NEW PRODUCT**



	CARNAVAL-1	CARNAVAL-2
	022-001-0001	022-001-0002
Watt	Max. 1000W	Max. 2000W
Cable	2*0,75mm <sup>2</sup>	2*1,5mm <sup>2</sup>

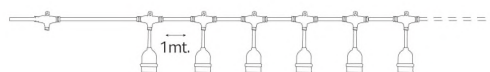

**HOROZ ELECTRIC**

# Декоративные настенно-потолочные светильники

## ILGAZ

220-240V / 50-60Hz

**CHROME + MAT CHROME**

Diffuser: Glass

ILGAZ-1	ILGAZ-2	ILGAZ-3	ILGAZ-4
026-001-0001	026-001-0002	026-001-0003	026-001-0004

Power	: Max. 60 W	Max. 60 W	Max. 2x60W	Max. 60 W
Sizes (mm)	: A: 90 B: 245	A: 90 B: 290	A: 105 B: 350	A: 310 B: 110 C: 160

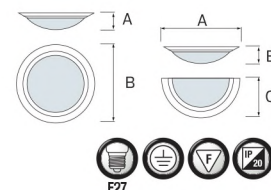

## KONAK

220-240V / 50-60Hz

**CHROME + MAT CHROME**

Diffuser: Glass

KONAK-1	KONAK-2	KONAK-3	KONAK-4
026-002-0001	026-002-0002	026-002-0003	026-002-0004

Power	: Max. 60 W	Max. 60 W	Max. 2X60W	Max. 60 W
Sizes (mm)	: A: 90 B: 220	A: 95 B: 260	A: 120 B: 330	A: 300 B: 110 C: 140

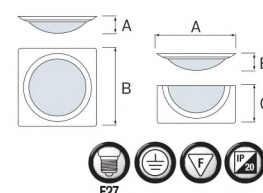

## ZARA

220-240V / 50-60Hz

**MAT CHROME**

Diffuser: Glass

ZARA-1	ZARA-2	ZARA-3	ZARA-4
026-003-0001	026-003-0002	026-003-0003	026-003-0004

Power	: Max. 60 W	Max. 2X60 W	Max. 3X60 W	Max. 60 W
Sizes (mm)	: A: 90 B: 230	A: 100 B: 285	A: 130 B: 370	A: 265 B: 110 C: 150

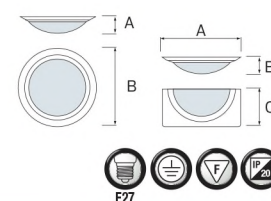

## LICE

220-240V / 50-60Hz

**MAT CHROME**

Diffuser: Glass

LICE-1	LICE-2
026-004-0001	026-004-0002

Power	: Max. 60 W	Max. 2X60 W
Sizes (mm)	: A: 35 B: 330	A: 35 B: 420

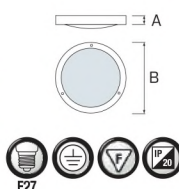
**HOROZ ELECTRIC**

## Декоративные настенно-потолочные светильники



## SARAY

220-240V / 50-60Hz

**MAT CHROME**

Diffuser: Glass

SARAY-1	SARAY-2	SARAY-3
026-005-0001	026-005-0002	026-005-0003

Power	: Max. 40 W	Max. 60 W	Max. 2X60 W
Sizes (mm)	: A: 70 mm B: 180	A: 73 B: 235	A: 75 B: 285

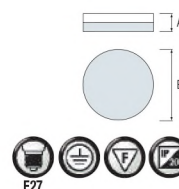



**HOROZ ELECTRIC**

## Декоративные потолочные светильники

### PHANTOM

- 185-265V / 50-60Hz
- Срок службы 30 000 Часов
- 6400K

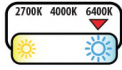

- WHITE
- BLUE
- PINK



PHANTOM-36	PHANTOM-48
027-002-0036	027-002-0048

Power	: 36 W	48 W
Luminous Flux	: 2500 lm	3330 lm
Sizes (mm)	: A: 410 B: 65	A: 510 B: 65

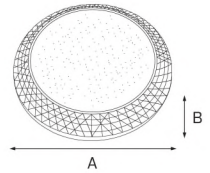

**HOROZ ELECTRIC**

## LED Потолочные светильники



### GHOST

- 185-265V / 50-60Hz
- Срок службы 30 000 Часов
- 6400K

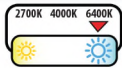

- WHITE
- BLUE
- PINK



GHOST-36	GHOST-48
027-003-0036	027-003-0048

Power	: 36 W	48 W
Luminous Flux	: 2500 lm	3330 lm
Sizes (mm)	: A: 400 B: 60	A: 490 B: 60

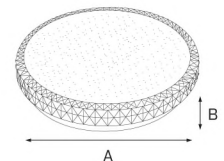



**HOROSZ ELECTRIC**

## Декоративные настенно-потолочные светильники

### SHARK-24

027 001 0024

WHITE

- 160-265V / 50-60Hz
- Срок службы 30 000 Часов
- 1800 lm
- 6400K

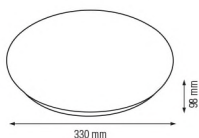

### PHOTON-15

027 005 0015

WHITE

- 120-265V / 50-60Hz
- Срок службы 30 000 Часов
- 1086 lm
- 6400K

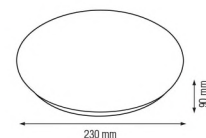

### EPSILON

- 185-265V / 50-60Hz
- Срок службы 30 000 Часов
- 6400 K

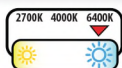

WHITE



	EPSILON-15	EPSILON-24	EPSILON-36
	027-004-0015	027-004-0024	027-004-0036

Power	: 15 W	24 W	36 W
Luminous Flux	: 1125 lm	1800 lm	2700 lm
Sizes (mm)	: A: 260 B: 55	A: 330 B: 60	A: 410 B: 60

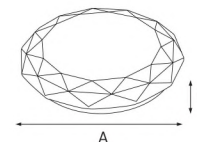



**HOROZ ELECTRIC**

LED настенные светильники

**SISAM**

029 006 0008

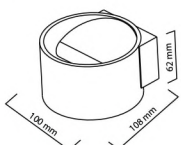

**TRUVA**

029 007 0008

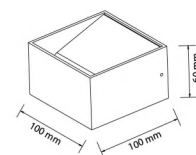

**WHITE**

**BLACK**

- 100-240V / 50-60Hz
- 8W
- 4200K
- 320 lm (SISAM) / 520 lm (TRUVA)
- Срок службы 30 000 Часов



**HOROZ ELECTRIC**

LED Настенные  
светильники



**ERDEK**

029 001 0005



**WHITE**

**RED**

- 220-240V / 50-60Hz
- 5W, 325 lm
- 4000K
- Срок службы 30 000 Часов

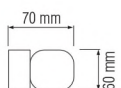

275 mm



**ABANT**

029 005 0010



**WHITE**

- 85-265V / 50-60Hz
- 10W
- 825 lm
- 4200K
- Срок службы 30 000 Часов

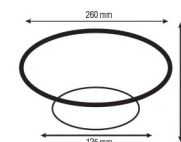



### RODOS

- 85-265V / 50-60Hz
- Срок службы 30 000 Часов
- 4000K

WHITE

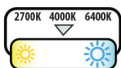

RODOS-3	RODOS-6	RODOS-12
029-004-0003	029-004-0006	029-004-0012

Power	: 3 W	6 W	12 W
Luminous Flux	: 170 lm	340 lm	950 lm
Sizes (mm)	: A: 200 B: 55 C: 100 D: 80	A: 300 B: 59 C: 179 D: 80	A: 480 B: 58 C: 345 D: 80

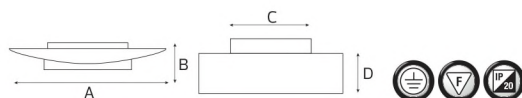

### BELEN

- 85-265V / 50-60Hz
- Срок службы 30 000 Часов
- 4000K

WHITE

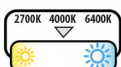

BELEN-6	BELEN-12	BELEN-18
029-003-0006	029-003-0012	029-003-0018

Power	: 6 W	12 W	18 W
Luminous Flux	: 340 lm	950 lm	1400 lm
Sizes (mm)	: A: 250 B: 105 C: 95	A: 420 B: 105 C: 95	A: 580 B: 105 C: 95

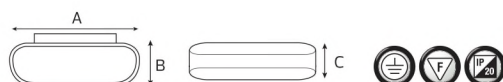



**HOROSZ ELECTRIC**

## LED Потолочные светильники / потолочные светильники

**LIKYA**

**CHROME**

■ 220-240V / 50-60Hz    ■ Срок службы 30 000 Часов  
■ 4000K

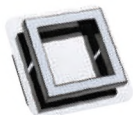

■ LIKYA-1



■ LIKYA-2



■ LIKYA-3



■ LIKYA-4



■ LIKYA-5



■ LIKYA-6



	LIKYA-1	LIKYA-2	LIKYA-3	LIKYA-4	LIKYA-5	LIKYA-6
	036-007-0001	036-007-0002	036-007-0003	036-007-0004	036-007-0005	036-007-0006
Power	: 5W	: 2x5W	: 3x5W	: 4x5W	: 4x5W	: 6x5W
Luminous Flux	: 300 lm	: 2x300 lm	: 3x300 lm	: 4x300 lm	: 4x300 lm	: 6x300 lm

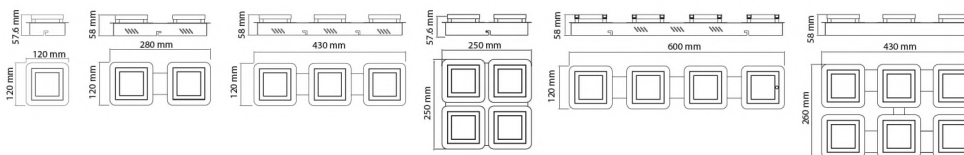

**HOROSZ ELECTRIC**

## LED Потолочные светильники

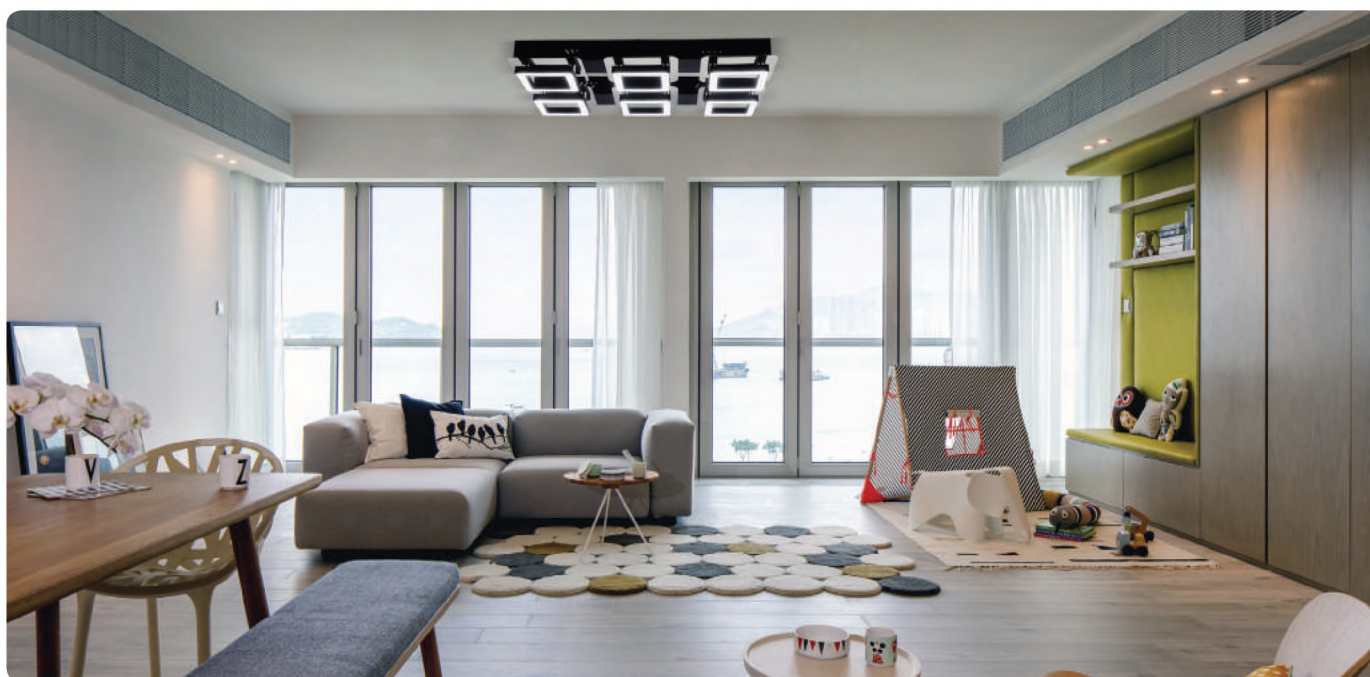





**DİDİM**

**CHROME**

■ 220-240V / 50-60Hz  
■ 4000K



	DİDİM-1	DİDİM-2	DİDİM-3	DİDİM-4	DİDİM-5
	036-005-0001	036-005-0002	036-005-0003	036-005-0004	036-005-0005
Power	: 3x5W	5W	2x5W	3x5W	4x5W
Luminous Flux	: 3x400 lm	400 lm	2x400 lm	3x400 lm	4x400 lm

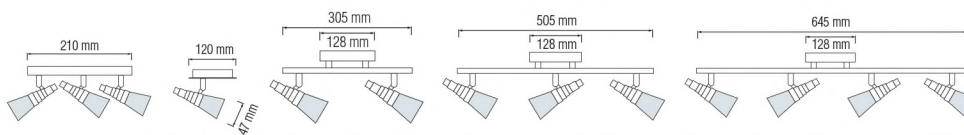

**MİLAS**

**CHROME**

■ 220-240V / 50-60Hz  
■ 4000K



	MİLAS-1	MİLAS-2	MİLAS-3	MİLAS-4	MİLAS-5
	036-004-0001	036-004-0002	036-004-0003	036-004-0004	036-004-0005
Power	: 3x5W	5W	2x5W	3x5W	4x5W
Luminous Flux	: 3x400 lm	400 lm	2x400 lm	3x400 lm	4x400 lm

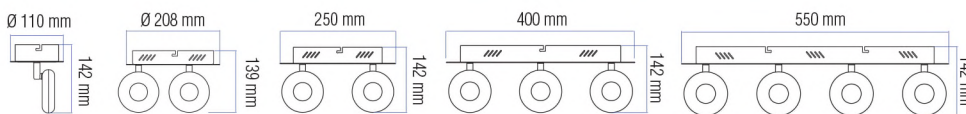

## LARA

CHROME

■ 220-240V / 50-60Hz  
■ 4000K



■ LARA-1



■ LARA-2



■ LARA-3



■ LARA-4



■ LARA-5



	LARA-1	LARA-2	LARA-3	LARA-4	LARA-5
	036-002-0001	036-002-0002	036-002-0003	036-002-0004	036-002-0005
Power	3x4W	4W	2x4W	3x4W	4x4W
Luminous Flux	3x260 lm	260 lm	2x260 lm	3x260 lm	4x260 lm

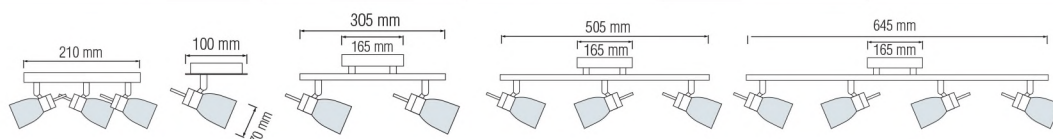

## SIDE

CHROME

■ 220-240V / 50-60Hz  
■ 4000K



■ SIDE-1



■ SIDE-2



■ SIDE-3



■ SIDE-4



■ SIDE-5



	SIDE-1	SIDE-2	SIDE-3	SIDE-4	SIDE-5
	036-003-0001	036-003-0002	036-003-0003	036-003-0004	036-003-0005
Power	3x5W	5W	2x5W	3x5W	4x5W
Luminous Flux	3x325 lm	325 lm	2x325 lm	3x325 lm	4x325 lm

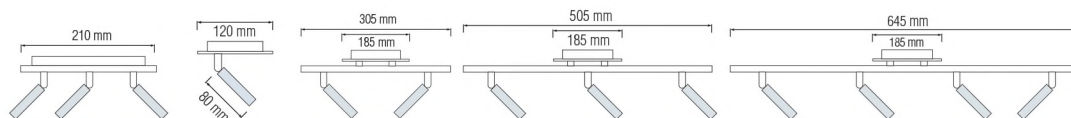



**PATARA**

**CHROME**

■ 220-240V / 50-60Hz  
■ 4000K



■ PATARA-1



■ PATARA-2



■ PATARA-3



■ PATARA-4



■ PATARA-5



	PATARA-1	PATARA-2	PATARA-3	PATARA-4	PATARA-5
	036-001-0001	036-001-0002	036-001-0003	036-001-0004	036-001-0005
Power	: 3x4W	4W	2x4W	3x4W	4x4W
Luminous Flux	: 3x260 lm	260 lm	2x260 lm	3x260 lm	4x260 lm

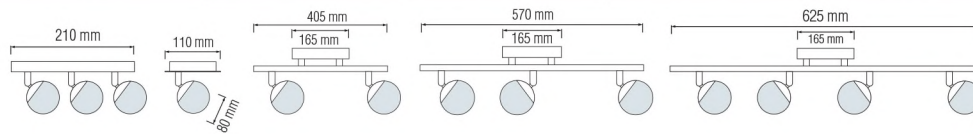

**EFES**

**CHROME**

■ 220-240V / 50-60Hz



■ EFES-1



■ EFES-2



■ EFES-3



■ EFES-4

	EFES-1	EFES-2	EFES-3	EFES-4
	035-006-0001	035-006-0002	035-006-0003	035-006-0004
Power	: Max.40W	Max.2x40W	Max.3x40W	Max.4x40W

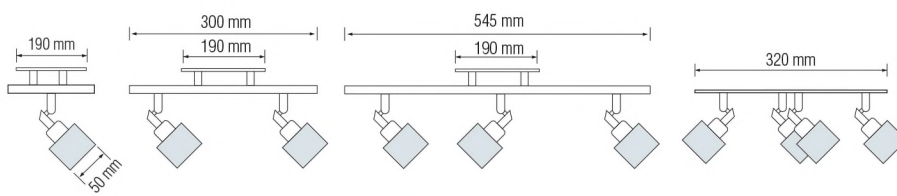

**HOROSZ ELECTRIC****LED Потолочные светильники /  
потолочные светильники****MANAVGAT****CHROME**

■ 220-240V / 50-60Hz



■ MANAVGAT-1



■ MANAVGAT-2



■ MANAVGAT-5



■ MANAVGAT-3



■ MANAVGAT-4

	MANAVGAT-1	MANAVGAT-2	MANAVGAT-3	MANAVGAT-4	MANAVGAT-5
	035-003-0001	035-003-0002	035-003-0003	035-003-0004	035-003-0005

<b>Power</b>	Max.40W	Max.2x40W	Max.3x40W	Max.4x40W	Max.3x40W
--------------	---------	-----------	-----------	-----------	-----------

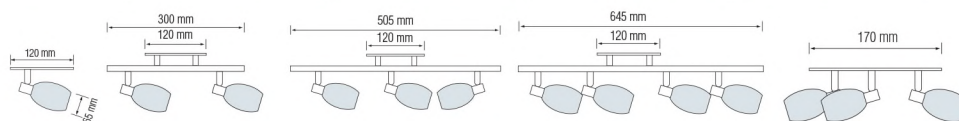
**BODRUM****CHROME**

■ 220-240V / 50-60Hz



■ BODRUM-1



■ BODRUM-2



■ BODRUM-3



■ BODRUM-4

	BODRUM-1	BODRUM-2	BODRUM-3	BODRUM-4
	035-004-0001	035-004-0002	035-004-0003	035-004-0004

<b>Power</b>	Max.40W	Max.2x40W	Max.3x40W	Max.4x40W
--------------	---------	-----------	-----------	-----------

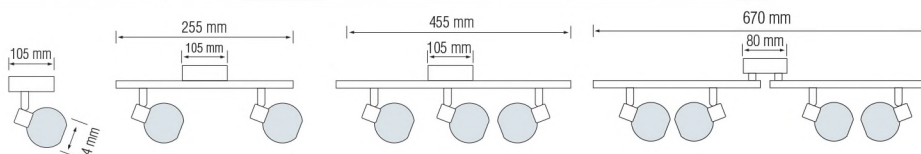



**KEMER**

**CHROME**

■ 220-240V / 50-60Hz



■ KEMER-1



■ KEMER-2



■ KEMER-5



■ KEMER-3



■ KEMER-4

	KEMER-1	KEMER-2	KEMER-3	KEMER-4	KEMER-5
	035-005-0001	035-005-0002	035-005-0003	035-005-0004	035-005-0005

<b>Power</b>	: Max.40W	Max.2x40W	Max.3x40W	Max.4x40W	Max.3x40W
--------------	-----------	-----------	-----------	-----------	-----------

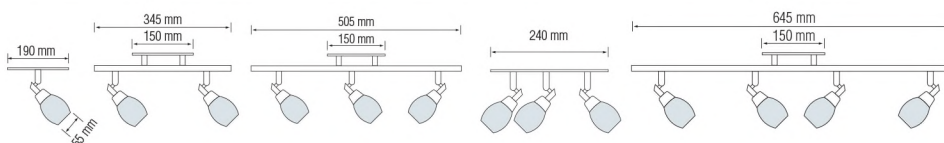

**BERGAMA**

**CHROME**

■ 220-240V / 50-60Hz



■ BERGAMA-1



■ BERGAMA-2



■ BERGAMA-3



■ BERGAMA-4



■ BERGAMA-5

	BERGAMA-1	BERGAMA-2	BERGAMA-3	BERGAMA-4	BERGAMA-5
	035-002-0001	035-002-0002	035-002-0003	035-002-0004	035-002-0005

<b>Power</b>	: Max.3x40W	Max.40W	Max.2x40W	Max.3x40W	Max.4x40W
--------------	-------------	---------	-----------	-----------	-----------

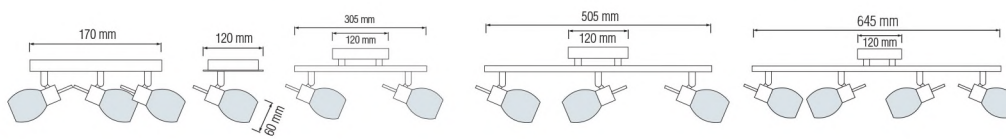



**HOROZ ELECTRIC**

## Светильники для ванной комнаты / Подсветка зеркал и картин

### AQUA



#### CHROME

220-240V / 50-60Hz



E14

AQUA-1	AQUA-3
037-001-0001	037-001-0003

Power	:	Max.40W	Max.3x40W
-------	---	---------	-----------

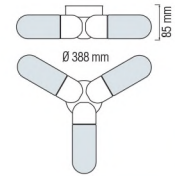
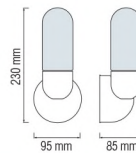

### VODA



#### CHROME

220-240V / 50-60Hz



E14

VODA-1	VODA-3
037-002-0001	037-002-0003

Power	:	Max.40W	Max.3x40W
-------	---	---------	-----------

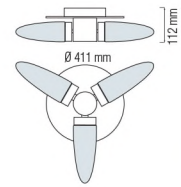
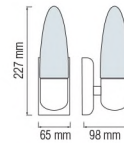

**HOROZ ELECTRIC**

## Светильники для ванной / Подсветка зеркал и картин





**HOROZ ELECTRIC**

Светильники для ванной комнаты /  
Подсветка зеркал и картин

**TOYGAR-12**

040 013 0012



**CHROME**

- 100-250V / 50-60Hz
- 1100 lm
- 4200K
- Срок службы 30 000 Часов

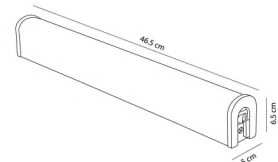

**SUMRU-12**

040 011 0012



**CHROME**

- 85-265V / 50-60Hz
- 1135 lm
- 4200K
- Срок службы 30 000 Часов

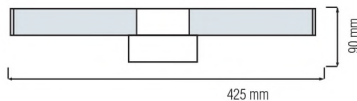

**EBABİL-12**

040 010 0012



**CHROME**

- 85-265V / 50-60Hz
- 1135 lm
- 4200K
- Срок службы 30 000 Часов

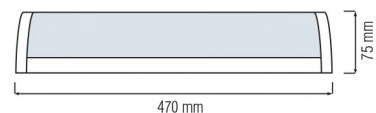

**HOROZ ELECTRIC**

# Светильники для ванной комнаты / Подсветка зеркал и картин

**ANKA**

- 100-250V / 50-60Hz
- Срок службы 30 000 Часов
- 4200 K

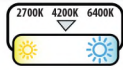
**CHROME**

ANKA-8	ANKA-12
040-014-0008	040-014-0012

Power	: 8 W	12 W
Luminous Flux	: 570 lm	850 lm
Sizes (mm)	: A: 400 B: 52 C: 185	A: 550 B: 52 C: 185

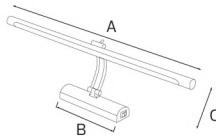
**KANARYA**

- 100-250V / 50-60Hz
- Срок службы 30 000 Часов
- 4200 K

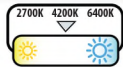
**CHROME**

KANARYA-8	KANARYA-12
040-012-0008	040-012-0012

Power	: 8 W	12 W
Luminous Flux	: 570 lm	850 lm
Sizes (mm)	: A: 405 B: 120 C: 120	A: 555 B: 120 C: 120

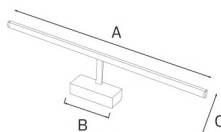



**FLAMINGO**

- 100-250V / 50-60Hz
- Срок службы 30 000 Часов
- 4200 K

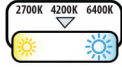

<b>FLAMINGO-4</b>	<b>FLAMINGO-6</b>
040-001-0004	040-001-0006

Power	: 4 W / 21LED	6 W / 30 LED
Luminous Flux	: 360 lm	500 lm
Sizes (mm)	: A: 405 B: 52 C: 175	A: 505 B: 52 C: 185

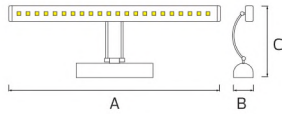
**CHROME****ALBATROS**

- 100-250V / 50-60Hz
- Срок службы 30 000 Часов
- 4200 K

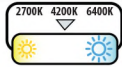

<b>ALBATROS-4</b>	<b>ALBATROS-6</b>
040-002-0004	040-002-0006

Power	: 4 W / 21LED	6 W / 30 LED
Luminous Flux	: 360 lm	500 lm
Sizes (mm)	: A: 407 B: 55 C: 100	A: 555 B: 55 C: 108

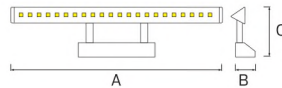
**CHROME****LORI**

- 85-265V / 50-60Hz
- Срок службы 30 000 Часов
- 4200 K

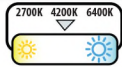

<b>LORI-6</b>	<b>LORI-9</b>
040-008-0006	040-008-0009

Power	: 6 W / 12 LED	9 W / 18 LED
Luminous Flux	: 360 lm	540 lm
Sizes (mm)	: A: 300 B: 180 C: 210	A: 380 B: 180 C: 210

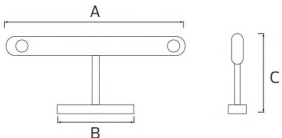
**CHROME****FLORYA**

- 100-265V / 50-60Hz
- Срок службы 30 000 Часов
- 4000 K

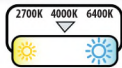

<b>FLORYA-3</b>	<b>FLORYA-6</b>	<b>FLORYA-9</b>
040-009-0003	040-009-0006	040-009-0009

Power	: 3 W	6 W	9 W
Luminous Flux	: 214 lm	428 lm	640 lm

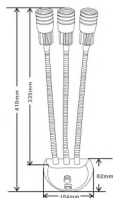
**CHROME**



**HOROZ ELECTRIC**

# Светильники для ванной комнаты / Подсветка зеркал и картин

## KUĞU

040 006 0003

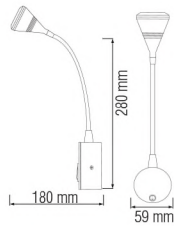

## TURNA

040 007 0003

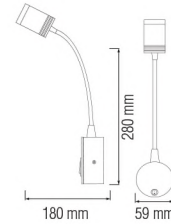

### SILVER

- 220-240V / 50-60Hz
- 200 lm
- 4200K
- Срок службы 30 000 Часов



## SAKA

040 004 0003

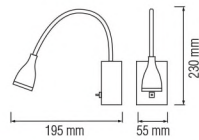

## MARTI

040 005 0003

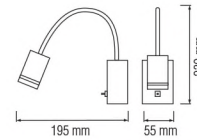

### RED

### WHITE

### BLACK

- 220-240V / 50-60Hz
- 130 lm
- 3000K
- Срок службы 30 000 Часов



## KUMRU

039 001 0001

### CHROME

### MAT CHROME

### GOLDEN

### TITANIUM BLACK



- Встроенный электронный трансформатор
- 220-240V / 50-60Hz 12V
- Max. 2x20W, 500 lm

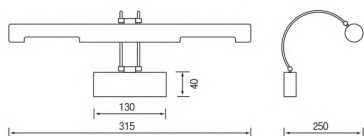

## HL 651

### CHROME

### MAT CHROME

- Встроенный электронный трансформатор
- 220-240V / 50-60Hz 12V
- Max. 2x20W (JC)
- Max. 2x35W (MR11)

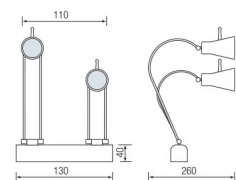

**HOROZ ELECTRIC**

Торшеры / LED Торшеры

**TUNA**

046 001 0003

**ARAS**

046 002 0003

**DICLE**

046 003 0003



RED

WHITE

BLACK

- 220-240V / 50-60Hz
- 3W, 130 lm
- 3000K
- Срок службы 25 000 Часов

**HOROZ ELECTRIC**

Торшеры / LED Торшеры

**MERİÇ**

■ 220-240V / 50-60Hz

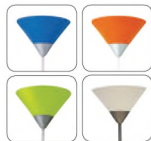

	MERİÇ-1	MERİÇ-2	MERİÇ-3
	045-001-0001	045-001-0002	045-001-0003

Power	: Max. 100 W	Max. 100 W (Mother) Max. 40 W (Baby)	Max. 100 W (Mother) Max. 40 W (Baby)
Lamp Holder	: E27	E27 (Mother)& E14 (Baby)	E27 (Mother)& E14 (Baby)
Color	: Blue / White / Green Orange	White	White
Sizes (mm)	: A: 250 B: 1800	A: 250 B: 1800 C: 500	A: 285 B: 1800 C: 500

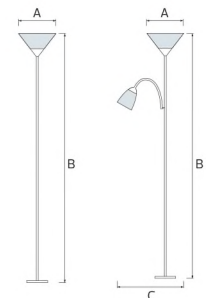

**ASTRO**

049 026 0006



**DIMMABLE**

**LED NIGHT LAMP**

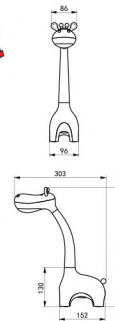

**WHITE**

**YELLOW**

**PINK**

- 100-240V / 50-60Hz
- 350 lm
- 3000K-4500K-6000K
- Срок службы 30 000 Часов



CCT Adjustable



LED Настольные лампы



**JUMBO**

049 027 0006



**DIMMABLE**

**LED NIGHT LAMP**

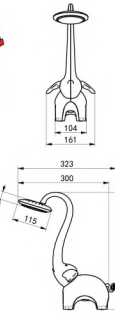

**WHITE**

**BLUE**

**PINK**

- 100-240V / 50-60Hz
- 350 lm
- 3000K-4500K-6000K
- Срок службы 30 000 Часов



CCT Adjustable



**FELIX**

049 028 0006



**DIMMABLE**

**LED NIGHT LAMP**

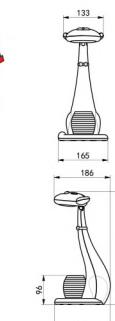

**WHITE**

**BLUE**

**PINK**

- 100-240V / 50-60Hz
- 350 lm
- 3000K-4500K-6000K
- Срок службы 30 000 Часов



CCT Adjustable



**SNOOPY**

049 029 0006



**DIMMABLE**

**LED NIGHT LAMP**

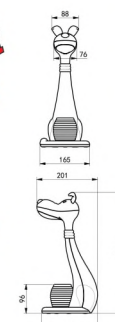

**WHITE**

**BLUE**

**YELLOW**

- 100-240V / 50-60Hz
- 350 lm
- 3000K-4500K-6000K
- Срок службы 30 000 Часов



CCT Adjustable



**EBRU** 049 010 0010

**BLACK**  
**WHITE**  
**SILVER**

- 100-240V / 50-60Hz
- 600 lm
- 3000K - 4500K - 6000K
- Срок службы 30 000 Часов

TOUCH

**DIMMABLE**

With Clips

10W SMD LED  
CCT Adjustable



**MERVE** 049 009 0005

**BLUE**  
**YELLOW**  
**PINK**

- 100-240V / 50-60Hz
- 300 lm
- 4600K
- Срок службы 30 000 Часов

TOUCH

**DIMMABLE**

5W SMD LED

**İREM** 049 011 0005

**RED**  
**WHITE**  
**BLACK**

- 100-240V / 50-60Hz
- 300 lm
- 4600K
- Срок службы 30 000 Часов

TOUCH

**DIMMABLE**

5W SMD LED

**DİLARA** 049 004 0003

**RED**  
**WHITE**  
**BLACK**

- 220-240V / 50-60Hz
- 130 lm
- 3000K
- Срок службы 30 000 Часов

ON-OFF

**POWER LED**

3W POWER LED

**BUKET** 049 005 0003

**RED**  
**WHITE**  
**BLACK**

- 220-240V / 50-60Hz
- 130 lm
- 3000K
- Срок службы 30 000 Часов

ON-OFF

**POWER LED**

3W POWER LED

**BERNA** 049 006 0003

BLACK  
WHITE  
BLUE  
RED

- 220-240V / 50-60Hz
- 130 lm
- 3000K
- Срок службы 30 000 Часов

98 mm  
535 mm  
135 mm

3W POWER LED 3000K 4200K 6400K

ON-OFF



**BİLGE** 049 008 0003

BLACK  
WHITE  
BLUE  
RED  
GREEN

- 220-240V / 50-60Hz
- 130 lm
- 3000K
- Срок службы 30 000 Часов

70 mm  
390 mm  
115 mm

3W POWER LED 3000K 4200K 6400K

ON-OFF

**BEYZA** 049 002 0003

RED  
WHITE  
BLACK

- 220-240V / 50-60Hz
- 130 lm
- 3000K
- Срок службы 30 000 Часов

270 mm  
100 mm

3W POWER LED 3000K 4200K 6400K

ON-OFF

**ALEYNA** 049 003 0003

RED  
WHITE  
BLACK

- 220-240V / 50-60Hz
- 130 lm
- 3000K
- Срок службы 30 000 Часов

370 mm  
127 mm

3W POWER LED 3000K 4200K 6400K

ON-OFF

**ECE** 049 001 0003

RED  
WHITE  
BLACK

- 220-240V / 50-60Hz
- 130 lm
- 3000K
- Срок службы 30 000 Часов

370 mm  
127 mm

3W POWER LED 3000K 4200K 6400K

ON-OFF

**BUDDY** 048 001 0015

**PINK**  
**BLUE**  
**YELLOW**

- 220-240V / 50-60Hz
- 15W
- 4500K
- 500 lm

2700K 4500K 6400K

G10q ON-OFF

Bulb Included

430 mm  
195 mm

**OSCAR** 048 002 0015

**PINK**  
**WHITE**  
**YELLOW**

- 220-240V / 50-60Hz
- 15W
- 4500K
- 500 lm

2700K 4500K 6400K

G10q ON-OFF

Bulb Included

450 mm  
230 mm

**TOBY** 048 003 0015

**ORANGE**  
**BLUE**  
**YELLOW**

- 220-240V / 50-60Hz
- 15W
- 4500K
- 500 lm

2700K 4500K 6400K

Bulb Included

G10q ON-OFF

400 mm  
205 mm

**KITTY** 048 004 0011

**PINK**  
**BLUE**  
**GREEN**

- 220-240V / 50-60Hz
- Max. 11W, 350 lm

2700K 4500K 6400K

PL G23 ON-OFF

Bulb Included

375 mm  
185 mm

**FLYER** 048 008 0011

**PINK**  
**BLUE**  
**YELLOW**

- 220-240V / 50-60Hz
- Max. 11W, 350 lm

2700K 4500K 6400K

PL G23 ON-OFF

Bulb Included

365 mm  
312 mm

**APPLE** 048 006 0011

**PINK**  
**BLUE**  
**YELLOW**

- 220-240V / 50-60Hz
- Max. 11W, 350 lm

2700K 4500K 6400K

PL G23 ON-OFF

Bulb Included

330 mm  
200 mm 165 mm

**DONALD** 048 007 0011

**BLUE**  
**ORANGE**  
**GREEN**

- 220-240V / 50-60Hz
- Max. 11W, 350 lm

2700K 4500K 6400K

Bulb Included

PL G23 ON-OFF

460 mm  
360 mm



**DERYA**

048 010 0060

**BLACK**
**WHITE**
**RED**

- 220-240V / 50-60Hz
- Max. 60W

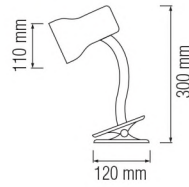
**DENİZ**

048 011 0040

**BLACK**
**WHITE**
**RED**

- 220-240V / 50-60Hz
- Max. 40W

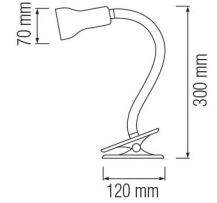
**BIHTER**

048 009 0060

**BLACK**
**WHITE**
**RED**
**BLUE**

- 220-240V / 50-60Hz
- Max. 60W

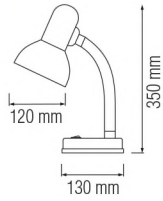
**RANA**

048 013 0060

**BLACK**
**WHITE**
**RED**

- 220-240V / 50-60Hz
- Max. 60W

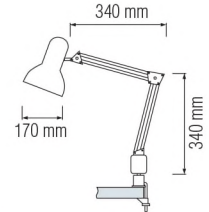
**SİMGE**

048 014 0060

**GREEN**
**BLUE**

- 220-240V / 50-60Hz
- Max. 60W

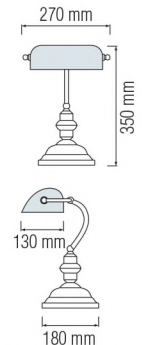





**HOROZ ELECTRIC**

## LED Ночники

085 001 0002

**REX**



WHITE

BLUE

GREEN

RED

- 220-240V / 50-60Hz
- 25 lm
- Срок службы 20 000 Часов

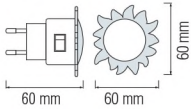

085 001 0003

**BUGS**



WHITE

BLUE

GREEN

RED

- 220-240V / 50-60Hz
- 20 lm
- Срок службы 20 000 Часов

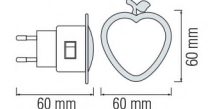

**HOROZ ELECTRIC**

## LED Ночники



085 001 0004

**MAX**



WHITE

BLUE

GREEN

RED

- 220-240V / 50-60Hz
- 25 lm
- Срок службы 20 000 Часов

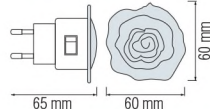

085 001 0005

**DUFFY**



WHITE

BLUE

GREEN

RED

- 220-240V / 50-60Hz
- 20 lm
- Срок службы 20 000 Часов

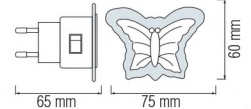

085 001 0001

**DORA**

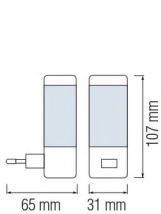

WHITE

BLUE

GREEN

RED

- 220-240V / 50-60Hz
- 25 lm
- Срок службы 20 000 Часов



085 001 0006

**SIMPSON**



WHITE

(LANDSCAPE)

- 220-240V / 50-60Hz
- 25 lm
- Срок службы 20 000 Часов

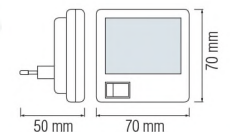

**HOROZ ELECTRIC****LED Линейные светильники****TETRA**

- 200-240V / 50-60Hz
- Срок службы 20 000 Часов
- 6400K

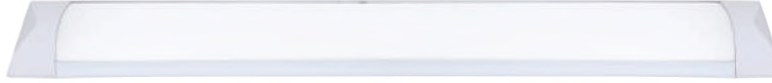
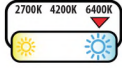

	TETRA-18	TETRA-36
	052-003-0060	052-003-0120

Power	: 18 W	36 W
Luminous Flux	: 1135 lm	2269 lm
Length (mm)	: L: 600	L: 1200

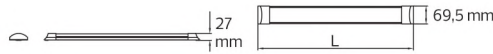
**HOROZ ELECTRIC****LED Линейные светильники****SIGMA**

- 220-240V / 50-60Hz
- Срок службы 20 000 Часов
- 6400K

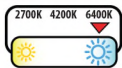

	SIGMA-4	SIGMA-7	SIGMA-10	SIGMA-14
	052-001-0030	052-001-0060	052-001-0090	052-001-0120

Power	: 4 W	7 W	10 W	14 W
Luminous Flux	: 254 lm	552 lm	846 lm	1100 lm
Length (mm)	: L: 282	L: 546	L: 856	L: 1156

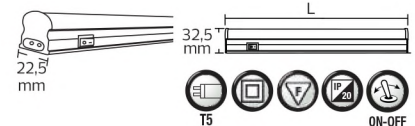
**OMEGA**

- 220-240V / 50-60Hz
- Срок службы 20 000 Часов
- 6400K

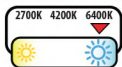

	OMEGA-6	OMEGA-9	OMEGA-12	OMEGA-16
	052-002-0030	052-002-0060	052-002-0090	052-002-0120

Power	: 6 W	9 W	12 W	16 W
Luminous Flux	: 273 lm	538 lm	898 lm	1136 lm
Length (mm)	: L: 285	L: 535	L: 855	L: 1155

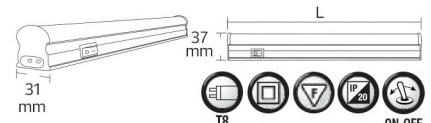

**HOROZ ELECTRIC**

# LED Пылевлагозащищённые линейные светильники

## IRMAK

- 170-265V/50-60Hz
- Срок службы 20 000 Часов
- 6400K

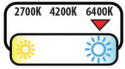

IRMAK-18	IRMAK-36	IRMAK-45
059-004-0018	059-004-0036	059-004-0045

Power	: 18 W	36 W	45 W
Luminous Flux	: 1440 lm	2880 lm	3600 lm
Length	: L: 650 mm	L: 1260 mm	L: 1560 mm



## NEHIR

- 170-265V/50-60Hz
- Срок службы 20 000 Часов
- 4200K / 6400K

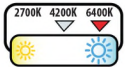

NEHIR-18	NEHIR-36	NEHIR-45
059-003-0018	059-003-0036	059-003-0045

Power	: 18 W	36 W	45 W
Luminous Flux	: 1440 lm	2880 lm	3600 lm
Length (mm)	: L: 652	L: 1262	L: 1562

**HOROZ ELECTRIC**

# LED Пылевлагозащищённые светильники



## OKYANUS

- 170-265V/50-60Hz
- Срок службы 20 000 Часов
- 6400K

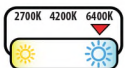

OKYANUS-36	OKYANUS-72	OKYANUS-90
059-005-0036	059-005-0072	059-005-0090

Power	: 36 W	72 W	90 W
Luminous Flux	: 2880 lm	5760 lm	7200 lm
Length (mm)	: L: 632	L: 1242	L: 1542

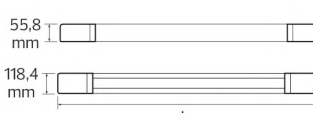

**HOROSZ ELECTRIC****Подвесные промышленные светильники****ZEUS**

062 001 0015

- 220-240V / 50-60Hz
- PC
- Max. 75W

**НЕБЬЮЩИЙСЯ****AFRODIT**

062 003 0025

- |              |              |
|--------------|--------------|
| <b>RED</b>   | <b>PINK</b>  |
| <b>GREEN</b> | <b>CLEAR</b> |
| <b>BLUE</b>  |              |
- 220-240V / 50-60Hz
  - PC
  - Max. 100W

**НЕБЬЮЩИЙСЯ****HOROSZ ELECTRIC****Подвесные промышленные светильники****APOLLON**

062 002 0015

- 220-240V / 50-60Hz
- PC
- Max. 75W

**НЕБЬЮЩИЙСЯ****EROS**

062 004 0045

- 220-240V / 50-60Hz
- PC
- Max. 200W

**НЕБЬЮЩИЙСЯ****GALYA**

062 007 0065

- 220-240V / 50-60Hz
- PC
- Max. 300W

**НЕБЬЮЩИЙСЯ****ARES**

062 006 0065

- 220-240V / 50-60Hz
- PC
- Max. 300W

**НЕБЬЮЩИЙСЯ**



### ASPENDOS

- 100-265V / 50-60Hz
- Срок службы 25 000 Часов
- 6400K
- Алюминиевый корпус

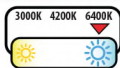

ASPENDOS-50	ASPENDOS-100	ASPENDOS-150	ASPENDOS-200
063-004-0050	063-004-0100	063-004-0150	063-004-0200

Power	: 50 W	100 W	150 W	200 W
Luminous Flux	: 4750 lm	9500 lm	14250 lm	19000 lm
Sizes (mm)	: A: 242.5 B: 172.5	A: 298.5 B: 175.1	A: 347.7 B: 176.8	A: 398.5 B: 178.1

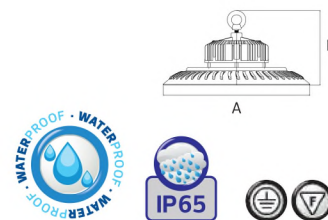

### ARTEMIS

- 160-250V / 50-60Hz
- Срок службы 25 000 Часов
- 6400K
- Алюминиевый корпус

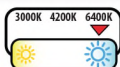

ARTEMIS-50	ARTEMIS-100	ARTEMIS-150	ARTEMIS-200
063-003-0050	063-003-0100	063-003-0150	063-003-0200

Power	: 50 W	100 W	150 W	200 W
Luminous Flux	: 5000 lm	10000 lm	15000 lm	20000 lm
Sizes (mm)	: A: 230 B: 120	A: 290 B: 120	A: 350 B: 120	A: 400 B: 120

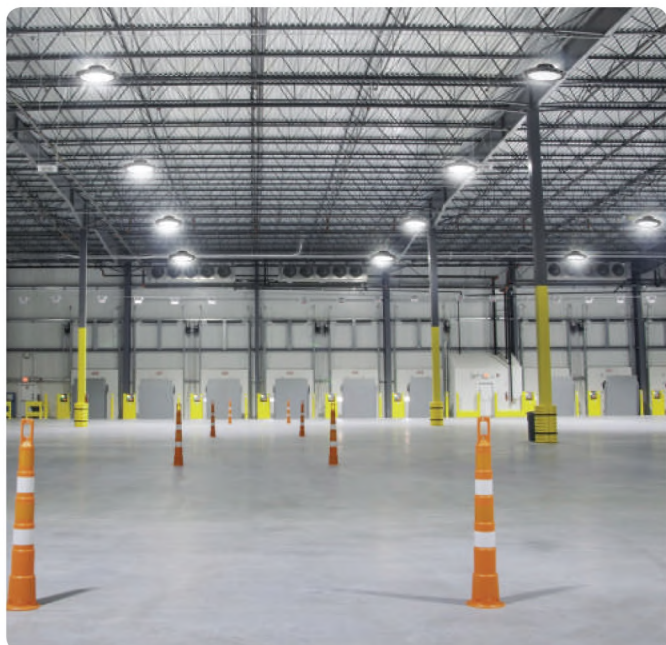
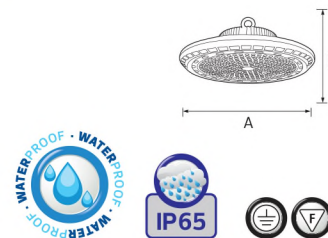

### OLIMPOS-100

063 002 0100

- 170-265V / 50-60Hz
- Алюминиевый корпус
- Срок службы 30 000 Часов
- 4200K
- 100W, 9200 lm



**KAPLAN-45**

068 007 0045



**BLACK**

- 220-240V / 50-60Hz
- Срок службы 50 000 Часов
- 45W, 5 400lm
- 4200K

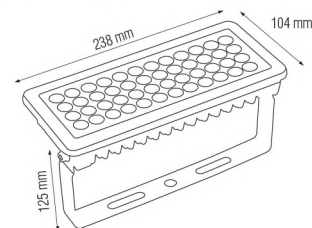

**KAPLAN-45W**

068 007 0001

крепление

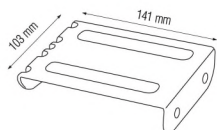

Projector Not Included

**KAPLAN-45S**

068 007 0002

крепление

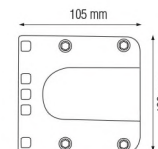

Projector Not Included

**KAPLAN-45C**

068 007 0003

крепление

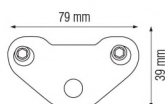

Projector Not Included



**HOROSZ ELECTRIC**

LED Прожекторы

**LION**

- 85-265V / 50-60Hz
- Срок службы 50 000 Часов
- 6400K

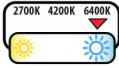
**BLACK**

	LION-50	LION-100	LION-150	LION-200	LION-300	LION-400	LION-500
	068-013-0050	068-013-0100	068-013-0150	068-013-0200	068-013-0300	068-013-0400	068-013-0500
Power	: 50 W	: 100 W	: 150 W	: 200 W	: 300 W	: 400 W	: 500 W
Luminous Flux	: 6000 lm	: 12000 lm	: 18000 lm	: 24000 lm	: 36000 lm	: 48000 lm	: 60000 lm
Sizes (mm)	: A:201 B:240 C:70	: A:223 B:272 C:78	: A:450 B:272 C:78	: A:450 B:400 C:78	: A:450 B:500 C:90	: A:560 B:610 C:94	: A:560 B:720 C:98

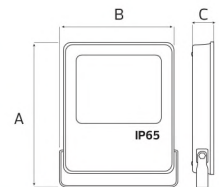
**LEOPAR**

- 85-265V / 50-60Hz
- Срок службы 50 000 Часов
- 2700K / 4200K / 6400K

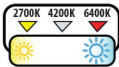
**BLACK**

	LEOPAR-20	LEOPAR-30	LEOPAR-50	LEOPAR-100	LEOPAR-150	LEOPAR-200
	068-006-0020	068-006-0030	068-006-0050	068-006-0100	068-006-0150	068-006-0200
Power	: 20 W	: 30 W	: 50 W	: 100 W	: 150 W	: 200 W
Luminous Flux	: 2400 lm	: 3600 lm	: 6000 lm	: 12000 lm	: 18000 lm	: 24000 lm
Sizes (mm)	: A:200 B:157 C:53	: A:215 B:171 C:50	: A:270 B:210 C:57	: A:305 B:253 C:75	: A:400 B:310 C:80	: A:390 B:310 C:95

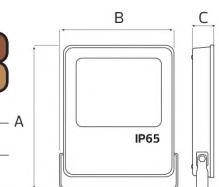

**HOROZ ELECTRIC**

## LED Прожекторы / Стойки под прожекторы

**PANTER**

- 85-265V / 50-60Hz
- 2700K / 4200K / 6400K
- Срок службы 50 000 Часов

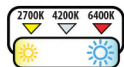
**BLACK**

	PANTER-50	PANTER-100	PANTER-150	PANTER-200	PANTER-300	PANTER-400
	068-005-0050	068-005-0100	068-005-0150	068-005-0200	068-005-0300	068-005-0400
Power	: 50 W	: 100 W	: 150 W	: 200 W	: 300 W	: 400 W
Luminous Flux	: 6000 lm	: 12000 lm	: 18000 lm	: 24000 lm	: 36000 lm	: 48000 lm
Sizes (mm)	: A: 245 B: 297 C: 75	: A: 246 B: 324 C: 75	: A: 315 B: 418 C: 90	: A: 314 B: 418 C: 90	: A: 345 B: 525 C: 100	: A: 355 B: 625 C: 100

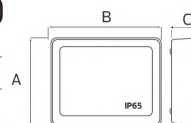
**HOROZ ELECTRIC**

## Стойки для прожекторов



107 001 0003

**PORTABLE**

- PORTABLE STAND
- 1.5 meter H05VV-F cable

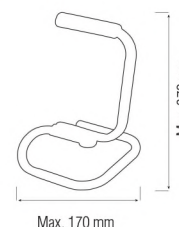
**TRIPOD SINGLE**

107 001 0001

- TRIPOD SINGLE STAND
- 1.8 meter H05VV-F cable

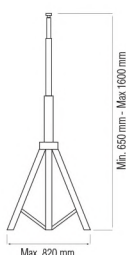
**TRIPOD DOUBLE**

107 001 0002

- TRIPOD DOUBLE STAND
- 1.8 meter H05VV-F cable

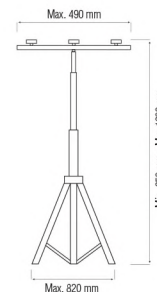



**HOROZ ELECTRIC****LED Прожекторы****ASLAN**

- 175-250V / 50-60Hz
- Срок службы 50 000 Часов

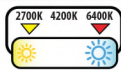
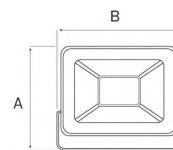
**BLACK**

B

A

C



	ASLAN-10	ASLAN-20	ASLAN-30	ASLAN-50	ASLAN-100	ASLAN-200
	068-010-0010	068-010-0020	068-010-0030	068-010-0050	068-010-0100	068-010-0200
Power	: 10 W	: 20 W	: 30 W	: 50 W	: 100 W	: 200 W
Luminous Flux	: 1200 lm	: 2400 lm	: 3600 lm	: 6000 lm	: 12000 lm	: 24000 lm
Color Temperature	: 2700K/6400K/GREEN	: 2700K/6400K/GREEN	: 2700K/6400K/GREEN	: 2700K/6400K/GREEN	: 2700K/6400K	: 2700K/6400K
Sizes (mm)	: A: 91,3 B: 97 C: 30,5	: A: 104,5 B: 128,4 C: 30,5	: A: 114,4 B: 154,3 C: 30,5	: A: 163,7 B: 224,3 C: 30,5	: A: 232,3 B: 294,5 C: 31	: A: 332,9 B: 420,8 C: 37

**ASLAN/S**

- 175-250V / 50-60Hz
- Срок службы 50 000 Часов
- 6400K

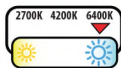
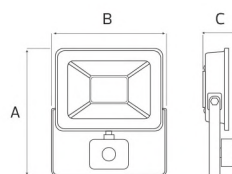
**С ДАТЧИКОМ****BLACK**

B

A

C



	ASLAN/S-20	ASLAN/S-30	ASLAN/S-50
	068-011-0020	068-011-0030	068-011-0050
Power	: 20 W	: 30 W	: 50 W
Luminous Flux	: 2400 lm	: 3600 lm	: 6000 lm
Sizes (mm)	: A: 171,6 B: 128,5 C: 50	: A: 180,1 B: 154,3 C: 52	: A: 226,5 B: 224,3 C: 52



### PARS

- 220-240V / 50-60Hz
- Срок службы 50 000 Часов

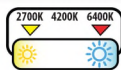

BLACK



	PARS-10	PARS-20	PARS-30	PARS-50	PARS-100
	068-008-0010	068-008-0020	068-008-0030	068-008-0050	068-008-0100
Power	: 10 W	: 20 W	: 30 W	: 50 W	: 100 W
Luminous Flux	: 1200 lm	: 2400 lm	: 3600 lm	: 6000 lm	: 12000 lm
Color Temperature	: 2700K/6400K/GREEN	: 2700K/6400K/GREEN	: 2700K/6400K/GREEN	: 2700K/6400K/GREEN	: 2700K/6400K
Sizes (mm)	: A: 96 B: 112 C: 25	: A: 122 B: 140 C: 28	: A: 151 B: 170 C: 30	: A: 186 B: 208 C: 33	: A: 239 B: 274 C: 42

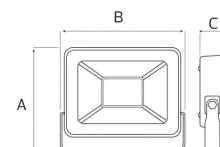

### PARS/S

- 220-240V / 50-60Hz
- Срок службы 50 000 Часов
- 6400K



BLACK



	PARS/S-10	PARS/S-20	PARS/S-30	PARS/S-50	PARS/S-100
	068-009-0010	068-009-0020	068-009-0030	068-009-0050	068-009-0100
Power	: 10 W	: 20 W	: 30 W	: 50 W	: 100 W
Luminous Flux	: 1200 lm	: 2400 lm	: 3600 lm	: 6000 lm	: 12000 lm
Sizes (mm)	: A: 157 B: 112 C: 40	: A: 174 B: 140 C: 40	: A: 196 B: 170 C: 40	: A: 213.5 B: 208 C: 40	: A: 265 B: 274 C: 44

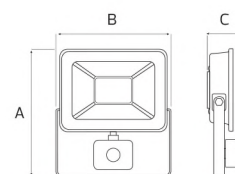

**PUMA**

- 175-250V / 50-60Hz
- Срок службы 20 000 Часов

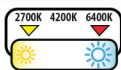

**BLACK**

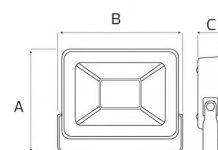

	PUMA-10	PUMA-20	PUMA-30	PUMA-50	PUMA-100	PUMA-200	PUMA-300
	068-003-0010	068-003-0020	068-003-0030	068-003-0050	068-003-0100	068-003-0200	068-003-0300
Power	: 10 W	: 20 W	: 30 W	: 50 W	: 100 W	: 200 W	: 300 W
Luminous Flux	: 1200 lm	: 2400 lm	: 3600 lm	: 6000 lm	: 12000 lm	: 24000 lm	: 36000 lm
Color Temperature	: 2700K/6400K/GREEN	: 2700K/6400K/GREEN	: 2700K/6400K/GREEN	: 2700K/6400K/GREEN	: 2700K/6400K	: 2700K/6400K	: 2700K/6400K
Sizes (mm)	: A: 94 B: 110 C: 33	: A: 109 B: 129 C: 37.5	: A: 128 B: 150 C: 38	: A: 153 B: 182 C: 38.5	: A: 220 B: 274 C: 41	: A: 273 B: 330 C: 76	: A: 312 B: 395 C: 95

**PUMA/S**

- 175-250V / 50-60Hz
- Срок службы 20 000 Часов
- 6400K

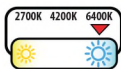

**С ДАТЧИКОМ**

**BLACK**

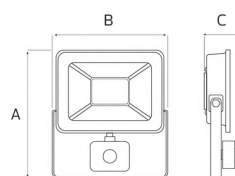

	PUMA/S-10	PUMA/S-20	PUMA/S-30	PUMA/S-50	PUMA/S-100
	068-004-0010	068-004-0020	068-004-0030	068-004-0050	068-004-0100
Power	: 10 W	: 20 W	: 30 W	: 50 W	: 100 W
Luminous Flux	: 1200 lm	: 2400 lm	: 3600 lm	: 6000 lm	: 12000 lm
Sizes (mm)	: A: 134 B: 110 C: 33	: A: 149 B: 129 mm C: 37.5	: A: 168 B: 150 C: 38.5	: A: 193 B: 182 C: 38.5	: A: 260 B: 274 C: 41



**HOROZ ELECTRIC**

## Уличные LED панели и линейные прожекторы

**FALCON**

RECESSED

**EAGLE**

SURFACED

069 001 0110

069 002 0110

- 100-240V / 50-60Hz
- 6400K
- 110W
- 11000 lm
- Срок службы 50 000 Часов

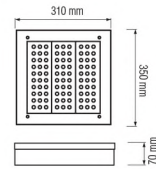
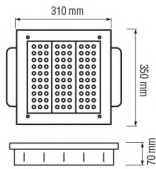

**HOROZ ELECTRIC**

## Уличные LED панели



**HOROZ ELECTRIC**

## Уличные линейные LED прожекторы



**REGAL**

AMBER 3000K RED GREEN BLUE



- 85-265V/50-60Hz
- Срок службы 50 000 Часов
- Алюминиевый корпус



	REGAL-9	REGAL-12	REGAL-18	REGAL-24	REGAL-36
	109-001-0009	109-001-0012	109-001-0018	109-001-0024	109-001-0036
Power	9 W	12 W	18 W	24 W	36 W
Luminous Flux	540 lm	720 lm	1080 lm	1440 lm	2160 lm
Length (mm)	255	330	480	630	930 mm

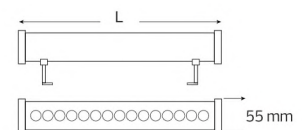



**HOROZ ELECTRIC**

LED Уличные светильники

**ORLANDO**

- 85-265V / 50-60Hz
- Срок службы 30 000 Часов
- 6400K

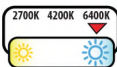

**BLACK**

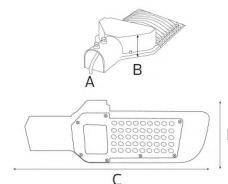

	ORLANDO-20	ORLANDO-30	ORLANDO-50	ORLANDO-100	ORLANDO-150	ORLANDO-200
	074-005-0020	074-005-0030	074-005-0050	074-005-0100	074-005-0150	074-005-0200
Power	: 20 W	: 30 W	: 50 W	: 100 W	: 150 W	: 200 W
Luminous Flux	: 1726 lm	: 2829 lm	: 4953 lm	: 8923 lm	: 15061 lm	: 17594 lm
Sizes (mm)	: A: 40 B: 55 C: 315 D: 105	: A: 40 B: 55 C: 355 D: 125	: A: 40 B: 55 C: 405 D: 165	: A: 60 B: 75 C: 620 D: 220	: A: 60 B: 75 C: 690 D: 250	: A: 60 B: 85 C: 740 D: 275



**HOROZ ELECTRIC**

LED Уличные светильники



## YILDIZ

- 100-240V / 50-60Hz
- Пластиковый корпус
- Срок службы 30 000 Часов



WHITE

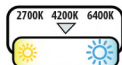

YILDIZ-8	YILDIZ-15
071-009-0008	071-009-0015

Power	: 8 W	15 W
Luminous Flux	: 560 lm	1080 lm
Sizes (mm)	: A: 76 B: 166 C: 62	A: 101 B: 201 C: 68

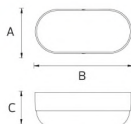

# Пылевлаго защищённые светильники



WHITE

BLACK

220-240V / 50-60Hz

NEMRUT

AYDER

TOROS

KAÇKAR



NEMRUT	AYDER	TOROS	KAÇKAR
070-001-0060	070-012-0100	070-002-0060	070-013-0100

Power	: Max.60 W	Max.100 W	Max.60 W	Max.100 W
Sizes (mm)	: A:210 B:80 C:105	A:275 B:115 C:155	A:210 B:85 C:105	A:275 B:120 C:155

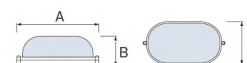

WHITE

BLACK

220-240V / 50-60Hz

ZİGANA

MUNZUR

ARARAT

ERCIYES



ZİGANA	MUNZUR	ARARAT	ERCIYES
070-005-0060	070-014-0100	070-006-0060	070-015-0100

Power	: Max.60 W	Max.100 W	Max.60 W	Max.100 W
Sizes (mm)	: A:180 B:85 C:180	A:240 B:110 C:140	A:170 B:80 C:170	A:240 B:115 C:240

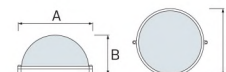

**HOROZ ELECTRIC****Садово-парковые светильники****KAVAK**

- 220-240V / 50-60Hz
- Алюминиевый корпус
- Рассеиватель из поликарбоната
- Max. 60W

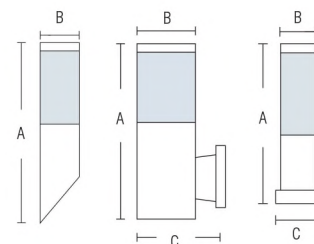
**BLACK****NEW PRODUCT**

	KAVAK-1	KAVAK-2	KAVAK-3	KAVAK-4	KAVAK-5
	075-014-0001	075-014-0002	075-014-0003	075-014-0004	075-014-0005
Sizes (mm)	A: 305 B: 89	A: 208 B: 89 C: 148	A: 300 B: 89 C: 130	A: 500 B: 89 C: 110	A: 800 B: 89 C: 110

**HOROZ ELECTRIC****Садово-парковые светильники****LADIN**

- 220-240V / 50-60Hz
- Нержавеющая сталь и гальванизированный стальной корпус
- Рассеиватель из поликарбоната
- Max. 60W

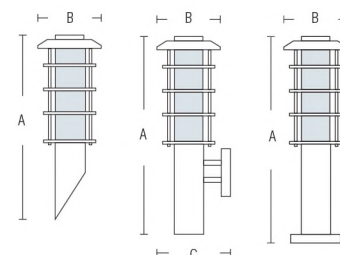

	LADIN-1	LADIN-2	LADIN-3	LADIN-4
	075-002-0001	075-002-0002	075-002-0003	075-002-0004
Sizes (mm)	A: 335 B: 120	A: 350 B: 120 C: 165	A: 500 B: 120	A: 800 B: 120





**KAYIN**

- 220-240V / 50-60Hz
- Нержавеющая сталь и гальванизированный стальной корпус
- Рассеиватель из стекла
- Max. 60W

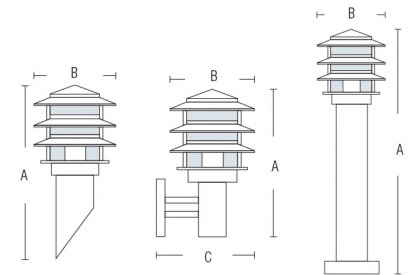

	KAYIN-1	KAYIN-2	KAYIN-3	KAYIN-4
	075-003-0001	075-003-0002	075-003-0003	075-003-0004
Sizes (mm)	A: 390 B: 150	A: 275 B: 150 B: 210	A: 450 B: 150	A: 800 B: 150



**PALMIYE**

- 220-240V / 50-60Hz
- Нержавеющая сталь и гальванизированный стальной корпус
- Рассеиватель из стекла
- Max. 100W

**BLACK**

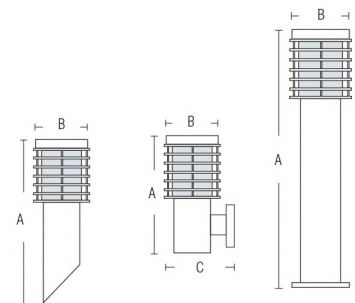

	PALMIYE-1	PALMIYE-2	PALMIYE-3	PALMIYE-4
	075-001-0001	075-001-0002	075-001-0003	075-001-0004
Sizes (mm)	A: 350 B: 150	A: 320 B: 150 B: 230	A: 500 B: 150	A: 800 B: 150







**DEFNE**

- 220-240V / 50-60Hz
- Нержавеющий стальной корпус
- Рассеиватель из поликарбоната
- Max. 60W

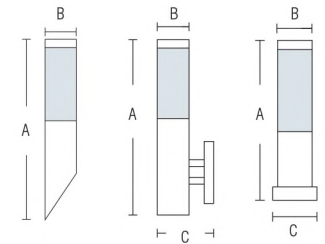

	DEFNE-1	DEFNE-2	DEFNE-3	DEFNE-4	DEFNE-5
	075-004-0001	075-004-0002	075-004-0003	075-004-0004	075-004-0005
Sizes (mm)	A:405 B:76	A:344 B:76 C:142	A:325 B:76 C:110	A:500 B:76 C:110	A:800 B:76 C:110



**BAMBU**

- 220-240V / 50-60Hz
- Срок службы 25 000 Часов
- 9W
- 684 lm
- 4000K

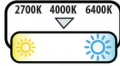

**MAT CHROME**

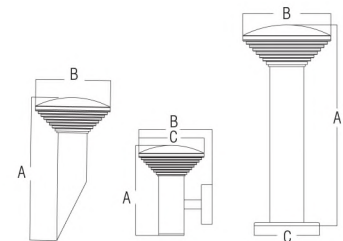

	BAMBU-1	BAMBU-2	BAMBU-3	BAMBU-4	BAMBU-5
	076-016-0001	076-016-0002	076-016-0003	076-016-0004	076-016-0005
Sizes (mm)	A:252.2 B:132	A:183 B:148.5 C:132	A:300 B:132 C:98	A:500 B:132 C:98	A:800 B:132 C:98



**MANGO**

- 220-240V / 50-60Hz
- Нержавеющая сталь и гальванизированный стальной корпус
- Рассеиватель из поликарбоната
- Max. 75W

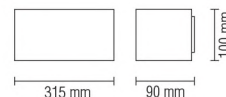
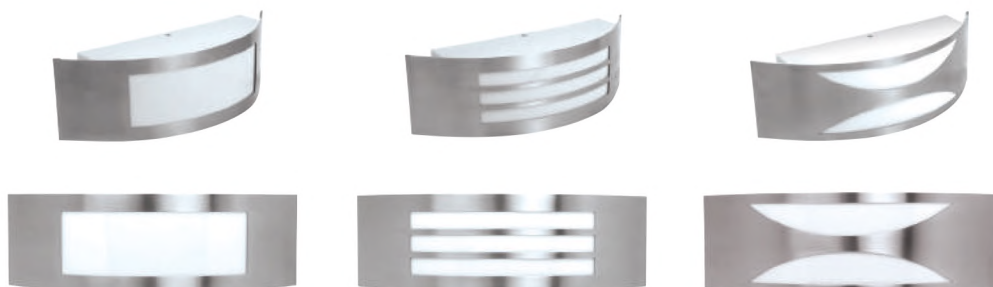

**MANGO-1**  
075-009-0001

**MANGO-2**  
075-009-0002

**MANGO-3**  
075-009-0003

**GARDENYA**

- 220-240V / 50-60Hz
- Нержавеющая сталь и гальванизированный стальной корпус
- Рассеиватель из поликарбоната

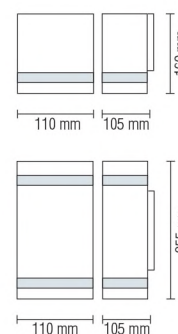

	GARDENYA-1	GARDENYA-2	GARDENYA-3	GARDENYA-4
	075-010-0001	075-010-0002	075-010-0003	075-010-0004

Power	:	Max.35W	Max.2x35W	Max.35W	Max.2x35W
-------	---	---------	-----------	---------	-----------

**MANOLYA**

- 220-240V / 50-60Hz
- Нержавеющая сталь и гальванизированный стальной корпус
- Рассеиватель из стекла



	MANOLYA-1	MANOLYA-2	MANOLYA-3
	075-008-0001	075-008-0002	075-008-0003

Power	:	Max.35W	Max.2x35W	Max.2x60W
Lamp Holder	:	GU10	GU10	E27
Body	:	Stainless Steel	Stainless Steel	Aluminium
Sizes (mm)	:	A: 116 B: 93 C: 85	A: 160 B: 93 C: 85	A: 300 B: 173 C: 108

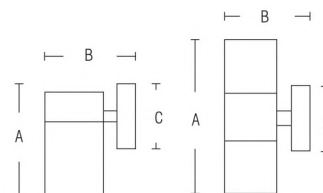

**HOROZ ELECTRIC****Садово-парковые светильники****SUGA**

- 85-265V / 50-60Hz
- 12W
- 4200K
- 1000 lm
- Срок службы 30 000 Часов

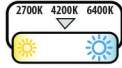
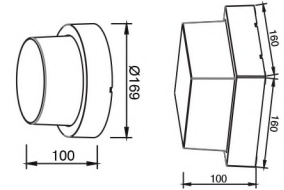
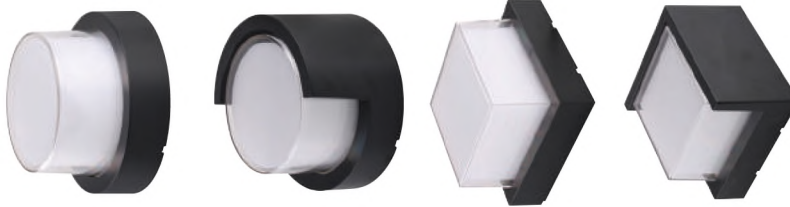
**BLACK**

SUGA-12/RO	SUGA-12/RC	SUGA-12/SO	SUGA-12/SC
076-021-0012	076-019-0012	076-022-0012	076-020-0012

Luminous Flux	:	1000 lm	700 lm	900 lm	650 lm
---------------	---	---------	--------	--------	--------

**ZEYTİN**

076 032 0012

**BLACK****BADEM**

076 028 0012

**DARK GREY****SUSAM**

076 030 0012

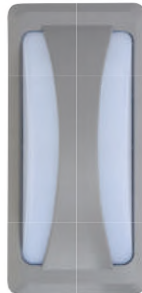
**DARK GREY****ILGIN**

076 029 0012

**DARK GREY**

- 100-240V / 50-60Hz
- 12W
- 4200K
- 480 lm
- Срок службы 30 000 Часов

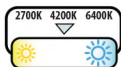
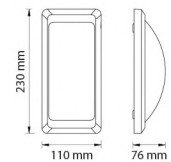

**HORUZ ELECTRIC****Садово-парковые светильники****ARENA**

076 033 0010

**NEW PRODUCT**

- 100-240V / 50-60Hz
- 750 lm
- 4200K
- Встроенный автоматический фотодатчик
- В комплекте наклейки (цифры и буквы)
- Срок службы 30 000 Часов

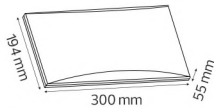
**48D****LED HOUSE NUMBER****KUKA-5**

076 031 0005

**NEW PRODUCT**

- 100-240V / 50-60Hz
- 4200K
- 290 lm
- Срок службы 30 000 Часов

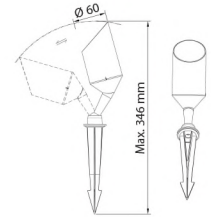
**HURMA**

076 010 0005

**MERSİN**

076 011 0005

**GÜRGEN**

076 012 0005

**DARK GREY**

- 100-240V / 50-60Hz
- 4200K
- 270 lm
- Срок службы 30 000 Часов

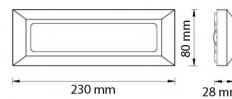
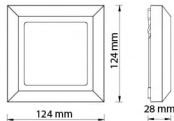
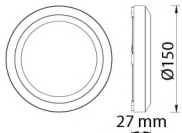
**IHLAMUR**

076 013 0002

**İĞDE**

076 014 0002

**İNCİR**

076 015 0002

**DARK GREY**

- 100-240V / 50-60Hz
- 4200K
- 110 lm
- Срок службы 30 000 Часов

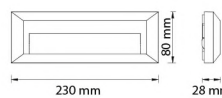
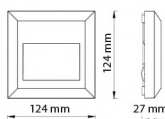
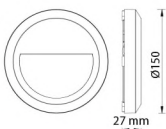
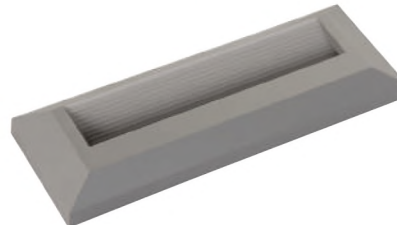
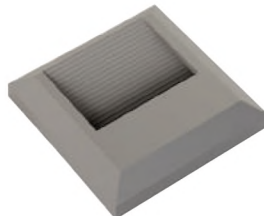
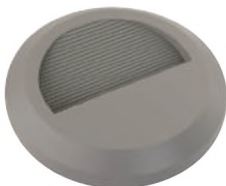

**SERVI**

076 009 0012

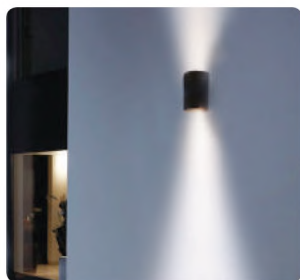
**BLACK****WHITE**

- 100-240V / 50-60Hz
- 4200K
- 750 lm
- Срок службы 30 000 Часов

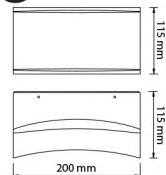
**ARDIÇ**

076 003 0006

**BLACK**

- Алюминиевый корпус
- 220-240V / 50-60Hz
- 4100K
- 385 lm
- Срок службы 30 000 Часов

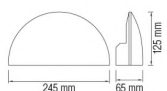
**SELVİ**

076 007 0004

**BLACK**

- Алюминиевый корпус
- 220-240V / 50-60Hz
- 4100K
- 35 lm
- Срок службы 30 000 Часов

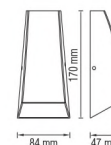
**MEŞE**

076 004 0006

**BLACK**

- Алюминиевый корпус
- 220-240V / 50-60Hz
- 4100K
- 420 lm
- Срок службы 30 000 Часов

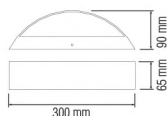
**SALKIM**

076 008 0004

**BLACK**

- Алюминиевый корпус
- 220-240V / 50-60Hz
- 4100K
- 65 lm
- Срок службы 30 000 Часов

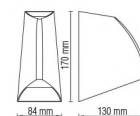
**ZAKKUM**

076 005 0003

**BLACK**

- Алюминиевый корпус
- 220-240V / 50-60Hz
- 4100K
- 230 lm
- Срок службы 30 000 Часов

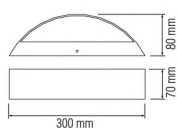
**TAFLAN**

076 006 0006

**BLACK**

- Алюминиевый корпус
- 220-240V / 50-60Hz
- 4100K
- 200 lm
- Срок службы 30 000 Часов



## SOLARIS

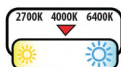

- Li-ION Battery 3.7V 2200 mAh
- 4000K
- Время зарядки: 4-6 от прямых солнечных лучей
- Срок службы 50 000 Часов

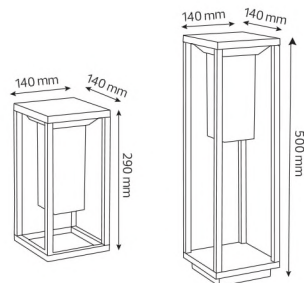

SOLARIS-1	SOLARIS-2
078-014-0001	078-014-0002

Power	: 2 W	2 W
Luminous Flux	: 220 lm (Strong) - 12 lm (Weak)	275 lm (Strong) - 18 lm (Weak)



# LED Светильники на солнечных батареях



## SIRIUS



WITH PIR SENSOR



- Li-ION Battery 3.7V 2200 mAh
- 4000K
- Время зарядки: 8-10 от прямых солнечных лучей
- Срок службы 50 000 Часов

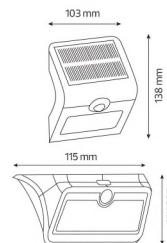

SIRIUS-1	SIRIUS-2
078-012-0001	078-012-0002

Power	: 1 W	2 W
Luminous Flux	: 140 lm (Strong) - 8 lm (Weak)	240 lm (Strong) - 12 lm (Weak)
Back Light	: Yes (Blue)	No





**HOROSZ ELECTRIC**

## LED Светильники на солнечных батареях

### OMNIA

078 013 0003



- Li-ION Battery 3.7V 1800 mAh
- 4000K
- 4 lm
- Время зарядки: 4-6 от прямых солнечных лучей
- USB зарядка
- Срок службы 50 000 Часов

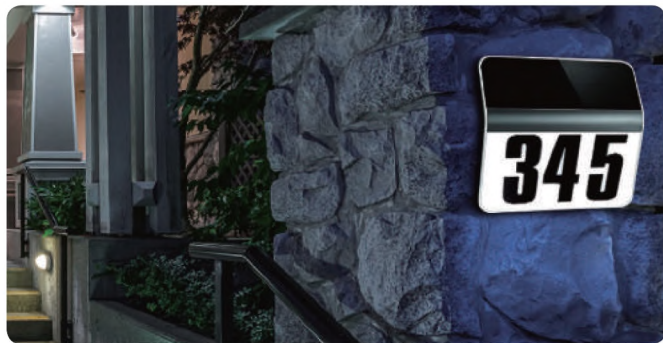
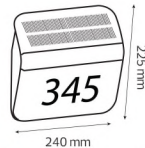

### VENÜS

078 001 0001



- Ni-MH AA 200 mAh 1.2V
- 6400K
- 1.5 lm
- Срок службы 50 000 Часов

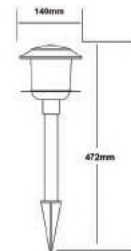

### CRYSTAL

078 009 0001



- Ni-MH AA 100 mAh 1.2V
- 6400K
- 1.5 lm
- Срок службы 50 000 Часов

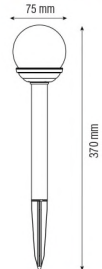

### ORBIT

078 010 0001



- Ni-MH AA 200 mAh 1.2V
- 6400K
- 1.5 lm
- Срок службы 50 000 Часов

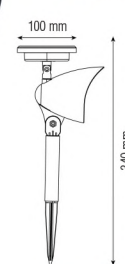

### LOTUS

078 011 0001



- Ni-MH AA 200 mAh 1.2V
- 6400K
- 1.5 lm
- Срок службы 50 000 Часов

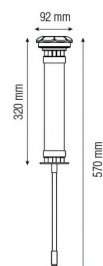

### MARS

078 002 0001



- Ni-MH AA 200 mAh 1.2V
- 6400K
- 1.5 lm
- Срок службы 50 000 Часов

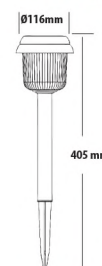

## PLUTON

078 005 0001



- Ni-MH AA 100 mAh 1.2V
- 6400K
- 1.5 lm
- Срок службы 100 000 Часов

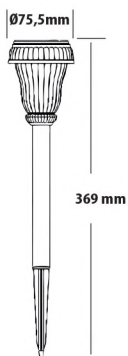

## NEPTUN

078 004 0001



- Ni-MH AA 100 mAh 1.2V
- 6400K
- 1.5 lm
- Срок службы 100 000 Часов



## HALLEY

078 006 0001



- Ni-MH AA 100 mAh 1.2V
- 6400K
- 1.5 lm
- Срок службы 100 000 Часов

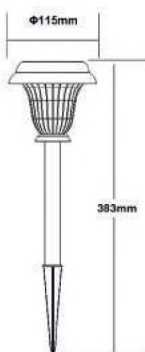

## MAGIC

078 007 0001



- 3 Ni-MH AA 100 mAh 1.2V
- 6400K
- 9x1.5 lm
- Срок службы 100 000 Часов

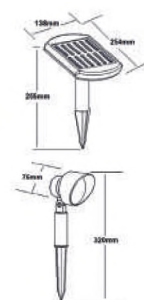

## WIZARD

078 008 0001



WITH PIR SENSOR

- 3 Ni-MH 600 mAh 1.2V
- 6400K
- 150 lm
- Срок службы 100 000 Часов

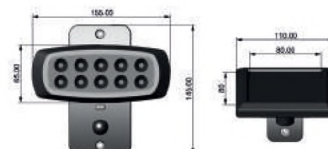





**HOROZ ELECTRIC**

## LED Встраиваемые грунтовые и лестничные светильники

**RUBY**

079 028 0002

**QUARTZ**

079 027 0002

**WHITE**

- 110-265V / 50-60Hz
- 100 lm
- 4000K
- Микроволновой датчик
- Срок службы 30 000 Часов

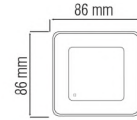

**HOROZ ELECTRIC**

## LED Встраиваемые грунтовые и лестничные светильники



**DIAMOND**

079 026 0002

**WHITE**

**BLACK**

**GOLD**

**SILVER**

- 110-265V / 50-60Hz
- 150 lm
- 4200K
- Микроволновой датчик
- Срок службы 30 000 Часов

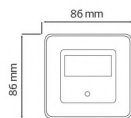

**GOLD**

079 025 0003

**WHITE**

- 220-240V / 50-60Hz
- 240 lm
- 4200K
- Инфракрасный датчик
- Срок службы 30 000 Часов



**WITH PIR SENSOR**

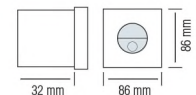



**HOROZ ELECTRIC**

# LED Встраиваемые грунтовые и лестничные светильники

**ZÜMRÜT**

079 001 0003

**YAKUT**

079 002 0003

**WHITE**

**MAT CHROME**

- 220-240V / 50-60Hz
- 86 lm
- 4000K
- Срок службы 30 000 Часов

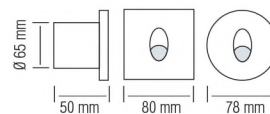

**İNÇİ**

079 004 0002

**SAFİR**

079 003 0002

- 220-240V / 50-60Hz
- 75 lm
- Срок службы 50 000 Часов

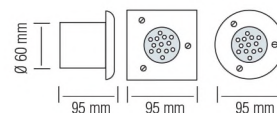

**ELMAS**

079 005 0002

**WHITE**

- 220-240V / 50-60Hz
- 198 lm
- Срок службы 50 000 Часов

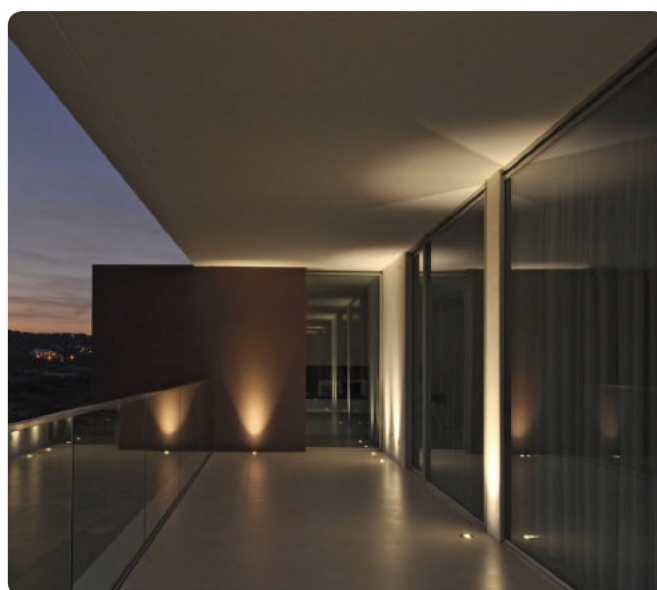
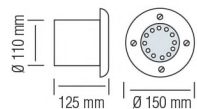

**HOROZ ELECTRIC**

# LED Встраиваемые грунтовые и лестничные светильники

- 220-240V / 50-60Hz
- Алюминий и нержавеющая сталь
- Срок службы 50 000 Часов

**SEDEF**  
**PERLE**

**OLTU**  
**AMBER**

**BERİL**  
**PERA**

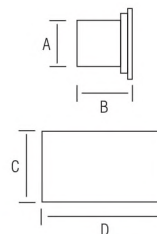

	SEDEF	PERLE	OLTU	AMBER	BERİL	PERA
	079-015-0002	079-021-0002	079-016-0002	079-022-0002	079-017-0002	079-023-0002

Power	: 1.6 W	1.2 W	1.6 W	1.2 W	1.6 W	1.2 W
Luminous Flux	: 90 lm	72 lm	90 lm	72 lm	90 lm	72 lm
Sizes (mm)	: A: 45 B: 58 C: 70 D: 170	A: 31 B: 58 C: 45 D: 110	A: 45 B: 58 C: 70 D: 170	A: 31 B: 58 C: 45 D: 110	A: 45 B: 58 C: 70 D: 170	A: 31 B: 58 C: 45 D: 110



- 220-240V / 50-60Hz
- Алюминий и нержавеющая сталь
- Срок службы 50 000 Часов

**MERCAN**  
**GÜMÜŞ**

**AKİK**  
**BRONZ**

**ONİKS**  
**BOR**



	MERCAN	GÜMÜŞ	AKİK	BRONZ	ONİKS	BOR
	079-012-0002	079-018-0001	079-013-0002	079-019-0001	079-014-0002	079-020-0001

Power	: 1.6 W	0.9 W	1.6 W	0.9 W	1.6 W	0.9 W
Luminous Flux	: 90 lm	57 lm	90 lm	57 lm	90 lm	57 lm
Sizes (mm)	: A: 70 B: 58 C: 105	A: 45 B: 58 C: 70	A: 70 B: 58 C: 105	A: 45 B: 58 C: 70	A: 70 B: 58 C: 105	A: 45 B: 58 C: 70

**KUVARS****KALSİT****OPAL****KORNET****GRANİT****PIRLANTA**

- 220-240V / 50-60Hz
- Срок службы 50 000 Часов

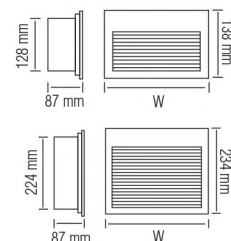
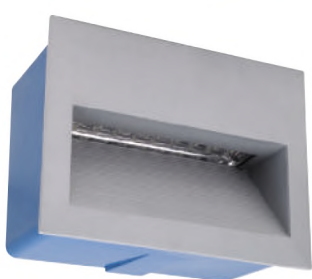

	KUVARS	KALSİT	OPAL	KORNET	GRANİT	PIRLANTA
	079-006-0002	079-007-0002	079-008-0003	079-009-0002	079-010-0002	079-011-0003

Power	: 1.5 W	1.8 W	2.7 W	1.5 W	1.8 W	2.7 W
Luminous Flux	: 90 lm	105 lm	160 lm	90 lm	105 lm	160 lm
Width (mm)	: W: 95	W: 140	W: 185	W: 95	W: 140	W: 185





**HOROZ ELECTRIC**

Светодиодные ленты / Драйверы / RGB-контроллеры / Неон

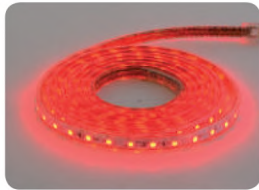

RED

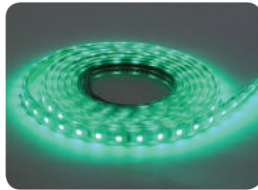

GREEN

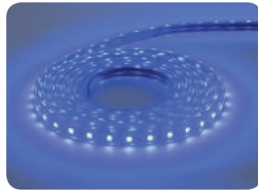

BLUE

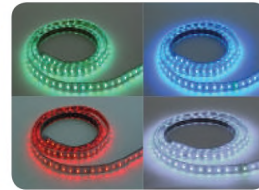

RGB



3000K



6400K



**THREE CHIPS**

**VOLGA**

081 004 0001

**VOLGA/RGB**

081 004 0002



**WATERPROOF**

- 220-240V / 50-60Hz
- 6W/m (RGB 9.5 W/m)
- 36.000 lm, per 164ft reel
- Срок службы 30 000 Часов
- Standart Length: 1m / 60 LED
- LED Type: 50x50 SMD
- LED View Angle: 120
- Package: 50 m / Roll
- 5 accessories



**NEW PRODUCT**

**220-240V**



Can be cut each 1 meter

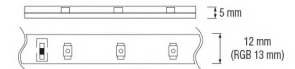

Светодиодные ленты / Драйверы / RGB-контроллеры / Неон



**HOROZ ELECTRIC**



RED

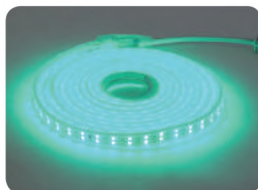

GREEN

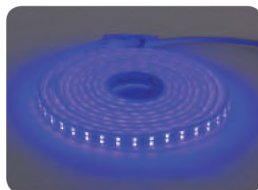

BLUE



RGB



3000K



4000K

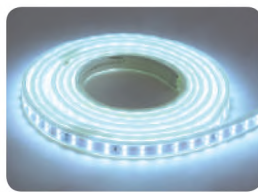

6400K



**SINGLE CHIP**

**COLORADO**

081 006 0001

**COLORADO/RGB**

081 006 0002



**WATERPROOF**

- 220-240V / 50-60Hz
- 5W/m (RGB 11W/m)
- 54.600 lm, per 164ft reel (RGB 37.800 lm, per 164ft reel)
- Срок службы 30 000 Часов
- Standart Length: 1m / 156 LED (RGB 1m / 108 LED)
- LED Type: 28x35 SMD
- LED View Angle: 120
- Package: 50 m / Roll
- 5 accessories



**NEW PRODUCT**

**220-240V**



Can be cut each 1 meter

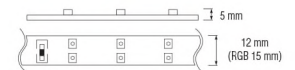



**HOROZ ELECTRIC**

Светодиодные ленты / Драйверы / RGB-контроллеры / Неон

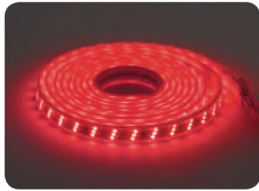

RED

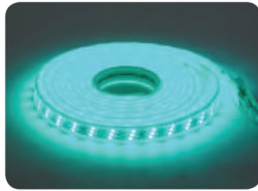

GREEN

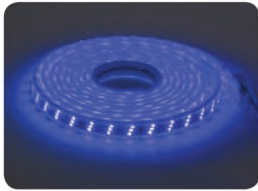

BLUE

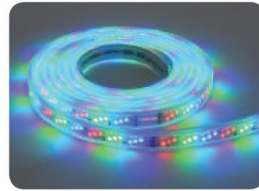

RGB

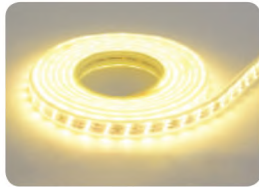

3000K

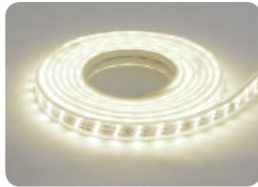

4000K



6400K



**SINGLE CHIP**



081 009 0001

081 009 0002



**WATERPROOF**

- 220-240V / 50-60Hz
- 7W/m (RGB 12.5 W/m)
- 63.000 lm, per 164ft reel
- Срок службы 30 000 Часов
- Standart Length: 1m / 180 LED
- LED Type: 28x35 SMD
- LED View Angle: 120
- Package: 50 m / Roll
- 5 accessories



**220-240V**



Can be cut each 1meter

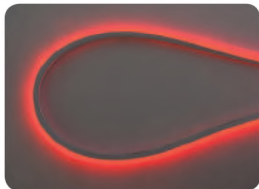
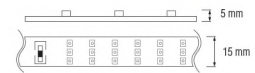

RED

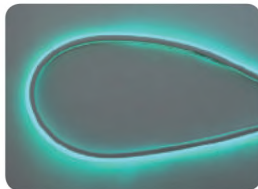

GREEN

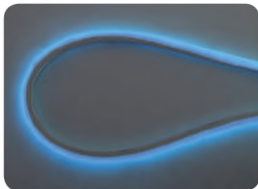

BLUE

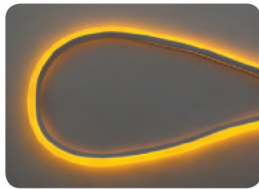

YELLOW

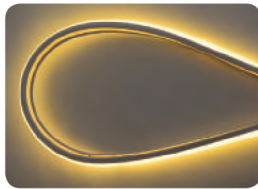

2700K

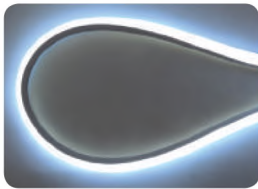

6400K

**NEOLED**

**WATERPROOF**

081 010 0001

**220-240V**



Can be cut each 1meter



- 220-240V / 50-60Hz
- 6.5W/m
- 264.000 lm / per 328ft. reel
- Срок службы 30 000 Часов
- Standart Length: 1m / 120 LED
- LED Type: 28x35 SMD
- LED View Angle: 120
- Package: 100m / Roll
- 5 accessories

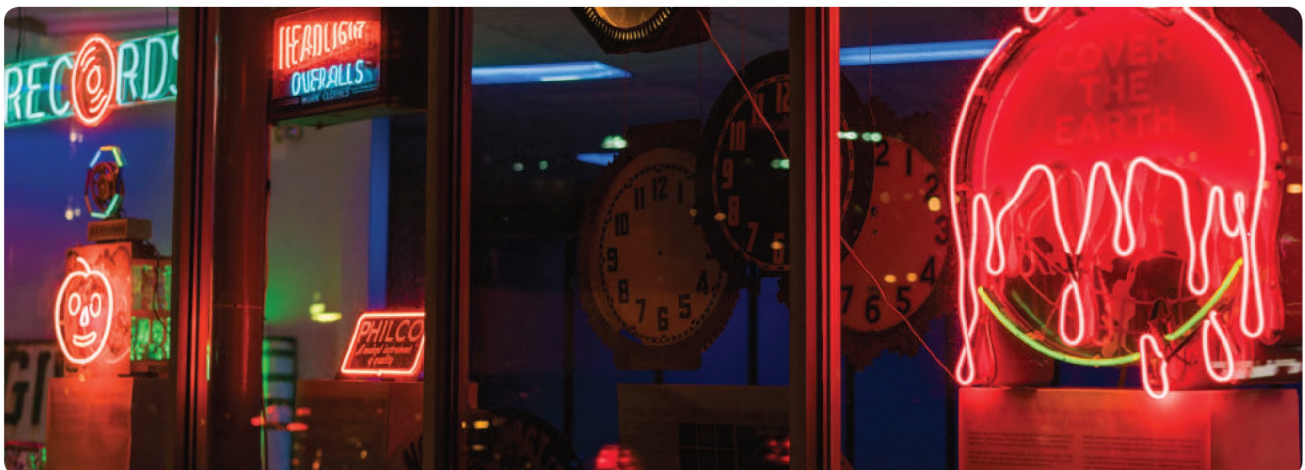



**RGB RF CONTROLLER**

■ 220-240V / 50-60Hz



**NEW PRODUCT**



<b>VOLGA RGB RF 1</b>	<b>COLORADO RGB RF 1</b>	<b>GANJ RGB RF 1</b>
081-004-0013	081-006-0013	081-009-0013
10 mm	12 mm	12 mm
3x1A, For Max.750W		

<b>VOLGA RGB RF 2</b>	<b>COLORADO RGB RF 2</b>	<b>GANJ RGB RF 2</b>
081-004-0014	081-006-0014	081-009-0014
10 mm	12 mm	12 mm
3x3A, For Max.1500W		



**SOCKET SET**

- 1 pcs 6A Socket (220V-)
- 1 pcs Connector
- 1 pcs Middle Plug
- 1 pcs End Cap
- 5 pcs Silicon Clips

**NEW PRODUCT**



<b>VOLGA SOCKET</b>	<b>COLORADO SOCKET</b>	<b>GANJ SOCKET</b>	<b>NEOLED SOCKET</b>
081-004-0011	081-006-0011	081-009-0011	081-010-0011
8 mm	10 mm	12 mm	6 mm

**RGB SOCKET SET**

- 1 pcs 6A 8 Function Socket (220V-)
- 1 pcs Connector
- 1 pcs Middle Plug
- 1 pcs End Cap
- 5 pcs Silicon Clips

**NEW PRODUCT**



<b>VOLGA RGB SOCKET</b>	<b>COLORADO RGB SOCKET</b>	<b>GANJ RGB SOCKET</b>
081-004-0012	081-006-0012	081-009-0012
10 mm	12 mm	12 mm

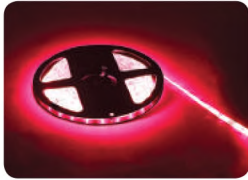

RED

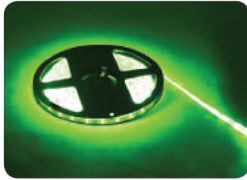

GREEN

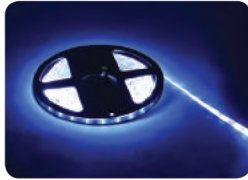

BLUE



RGB



3000K



4200K

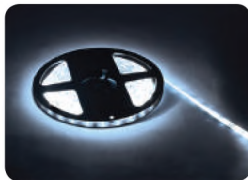

6400K



**SINGLE CHIP**

**REN**

081 001 0001

**REN/RGB**

081 001 0002

**12V DC**

**WATERPROOF**

- 12V DC
- Input Current: 2A (1Roll/5m)
- 24W (1 Roll/5m)
- 1.440 lm, per 16ft reel
- Срок службы 30 000 Часов
- Standart Length: 1m / 60 LED
- LED Type: 35x28 SMD
- LED View Angle: 120
- Package: 5 m / Roll
- PCB Color: White
- With 3M self-adhesive backing for easy installation



3 LEDs make a group and each group can be cut or extended in terms of the length of application

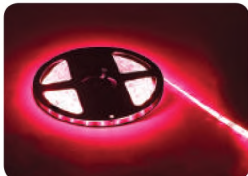
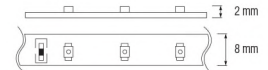

RED

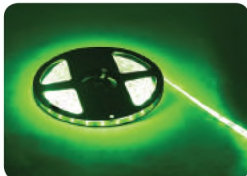

GREEN

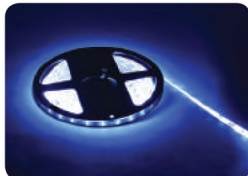

BLUE



RGB



3000K



4200K



6400K



**SINGLE CHIP**

**NIŁ**

081 002 0001

**NIŁ/RGB**

081 002 0002

**12V DC**

**NON WATERPROOF**

- 12V DC
- Input Current: 2A (1Roll/5m)
- 24W (1 Roll/5m)
- 1.440 lm, per 16ft reel
- Срок службы 30 000 Часов
- Standart Length: 1m / 60 LED
- LED Type: 35x28 SMD
- LED View Angle: 120
- Package: 5 m / Roll
- PCB Color: White
- With 3M self-adhesive backing for easy installation



3 LEDs make a group and each group can be cut or extended in terms of the length of application

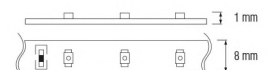



**HOROZ ELECTRIC**

Светодиодные ленты / Драйверы / RGB-контроллеры / Неон

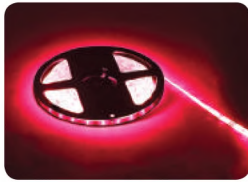

RED

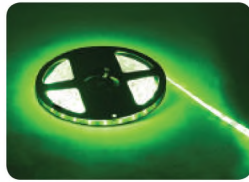

GREEN

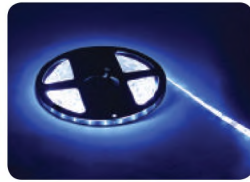

BLUE



RGB



3000K

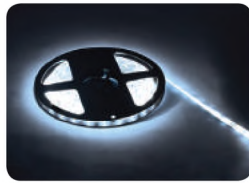

6400K



**THREE CHIPS**

**THAMES**

081 003 0001

**THAMES/RGB**

081 003 0002

**12V DC**

**WATERPROOF**

- 12V DC
- Input Current: 6A (1 Roll/5m)
- 72W (1 Roll/5m)
- 4.320 lm, per 16ft reel
- Срок службы 30 000 Часов
- Standart Length: 1m / 60 LED
- LED Type: 50x50 SMD
- LED View Angle: 120
- Package: 5 m / Roll
- PCB Color: White
- With 3M self-adhesive backing for easy installation



3 LEDs make a group and each group can be cut or extended in terms of the lenght of application

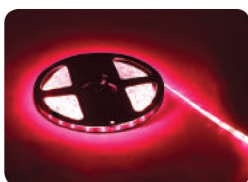
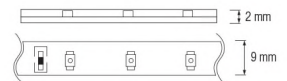

RED

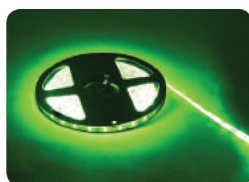

GREEN

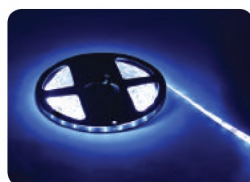

BLUE



RGB



3000K

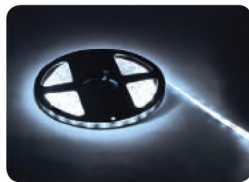

6400K



**THREE CHIPS**

**AMAZON**

081 005 0001

**AMAZON/RGB**

081 005 0002

**12V DC**

**NON WATERPROOF**

- 12V DC
- Input Current: 6A (1 Roll/5m)
- 72W (1 Roll/5m)
- 4.320 lm, per 16ft reel
- Срок службы 30 000 Часов
- Standart Length: 1m / 60 LED
- LED Type: 50x50 SMD
- LED View Angle: 120
- Package: 5 m / Roll
- PCB Color: White
- With 3M self-adhesive backing for easy installation



3 LEDs make a group and each group can be cut or extended in terms of the lenght of application

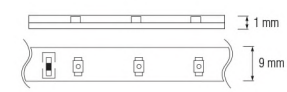



**HOROZ ELECTRIC**

# Светодиодные ленты / Драйверы / RGB-контроллеры / Неон

**VEGA**

- Input Voltage: AC 220–240V / 50–60Hz
- Output Voltage: DC 12V

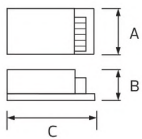

	VEGA-10	VEGA-36	VEGA-60	VEGA-100	VEGA-150	VEGA-200	VEGA-250	VEGA-360
	082-001-0010	082-001-0036	082-001-0060	082-001-0100	082-001-0150	082-001-0200	082-001-0250	082-001-0360
Output Power	10 W	36 W	60 W	100 W	150 W	200 W	250 W	360 W
Output Current	0.8A	3A	5A	8.5A	12A	17A	20.8A	30A
35x28 SMD LED Strip	2m	5m	10m	20m	30m	40m	50m	70m
50x50 SMD LED Strip	1m	1.5m	4m	6.5m	10m	13m	17m	24m
Size (mm)	A: 35 B: 22 C: 77	A: 32 B: 27 C: 140	A: 40 B: 30 C: 160	A: 40 B: 30 C: 160	A: 57 B: 42 C: 200	A: 67 B: 40 C: 220	A: 62 B: 40 C: 225	A: 62 B: 40 C: 225

**VESTA**

- Input Voltage: AC 220–240V / 50–60Hz
- Output Voltage: DC 12V

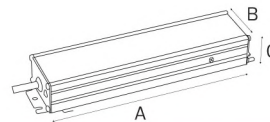
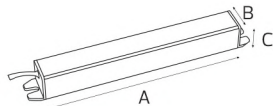
**WATERPROOF**

	VESTA-18	VESTA-25	VESTA-45	VESTA-60	VESTA-100	VESTA-150	VESTA-200
	083-001-0018	083-001-0025	083-001-0045	083-001-0060	083-001-0100	083-001-0150	083-001-0200
Output Power	18 W	25 W	45 W	60 W	100 W	150 W	200 W
Output Current	1.5 A	2A	3.75 A	5A	8.5 A	12.5A	17A
Protection Class	II	II	II	II	I	I	I
35x28 SMD LED Strip	3.5m	5m	8m	12m	20m	30m	40m
50x50 SMD LED Strip	1.2m	1.7m	2.5m	4m	6.5m	10m	13m
Size (mm)	A: 186 B: 20 C: 20	A: 186 B: 20 C: 20	A: 307 B: 20 C: 20	A: 307 B: 20 C: 20	A: 220 B: 51 C: 32	A: 230 B: 65 C: 32	A: 252 B: 70 C: 45

**HOROSZ ELECTRIC**

# Драйверы / Гирлянды

100 001 0072

RGB Controller 2A



- Input Voltage: DC 12V - 24V
- Output Voltage: DC 12V - 24V
- Output Power: 72W
- Output Current: 2A/Each Color

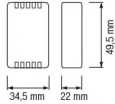

For Max. 15m 35x28 SMD LED Strip  
For Max. 5m 50x50 SMD LED Strip



100 002 0144

RGB Controller 4A



- Input Voltage: DC 12V - 24V
- Output Voltage: DC 12V - 24V
- Output Power: 144W
- Output Current: 4A/Each Color

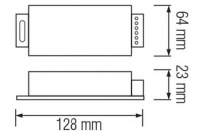

For Max. 30m 35x28 SMD LED Strip

For Max. 10m 50x50 SMD LED Strip

**AMPLIFIER**

- Input Voltage: DC 12V - 24V
- Output Voltage: DC 12V - 24V

AMPLIFIER-12A

101-001-0144

AMPLIFIER-24A

101-001-0288

Output Power	: 144 W	288 W
Output Current	: 4A/Each Color	8A/Each Color
35x28 RGB LED Strip	: 30 Meters with 60Leds/Meter	60 Meters with 60Leds/Meter
50x50 RGB LED Strip	: 10 Meters with 60Leds/Meter	20 Meters with 60Leds/Meter

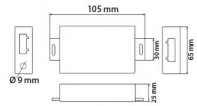
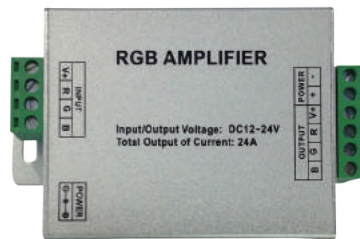
**HOROSZ ELECTRIC**

# Драйверы / Гирлянды

**MONTANA**

- 4.5V DC
- 4W/10 m
- Срок службы 25 000 Часов
- Standart Length: 1 m / 10 LED
- Package: 10 m / Roll

080 001 0004

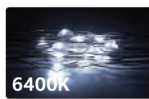
**MONTANA-D4**

080 001 0001

- 100-240V / 50-60Hz
- 16W/40 m

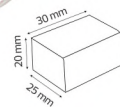
**MONTANA-D10**

080 001 0002

- 100-240V / 50-60Hz
- 40W/100 m

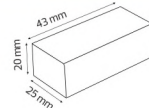

**HOROZ ELECTRIC**

# LED аварийные светильники и фонари



## LED Аварийные светильники и фонари



084 022 0010

**ROMARIO****RECHARGEABLE****SOLAR**

- 220-240V / 50-60Hz
- 10W, 360 lm
- 4V 1600mAh Перезаряжаемый герметичный кислотный аккумулятор
- Время работы: 1 час / сильный свет  
25 часов / слабый свет
- Срок службы 30 000 Часов

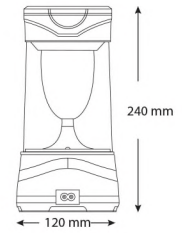
**BEST**

- 220-240V / 50-60Hz
- Срок службы 30 000 Часов
- Время работы: 1 час / сильный свет  
4 часов / слабый свет

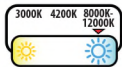

	BEST-1	BEST-3	BEST-5
	084-024-0001	084-024-0003	084-024-0005

Power	: 1 W	3 W	5 W
Luminous Flux	: 70 lm	120 lm	210 lm
Battery	: 4V 0.4Ah Sealed-Acid	4V 0.9Ah Sealed-Acid	4V 1.6Ah Sealed-Acid
Sizes (mm)	: A: 51 B: 200	A: 65 B: 220	A: 85 B: 240

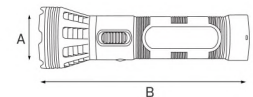

OFF-1-2

**PELE**

- 220-240V / 50-60Hz
- Срок службы 30 000 Часов
- Время работы: 1 час / сильный свет  
4 часов / слабый свет

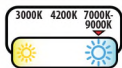

	PELE-1	PELE-2	PELE-3
	084-006-0001	084-006-0002	084-006-0003

Power	: 0.5 W	1 W	3 W
Luminous Flux	: 30 lm	73 lm	120 lm
Battery	: 4V 200mAh Sealed-Acid	4V 400mAh Sealed-Acid	4V 900mAh Sealed-Acid
Sizes (mm)	: A: 65 B: 220	A: 51 B: 155	A: 65 B: 170

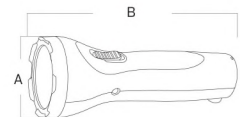

OFF-1-2

**HOROZ ELECTRIC**

## LED аварийные светильники и фонари

**MARADONA**

- 220-240V / 50-60Hz
- Срок службы 30 000 Часов

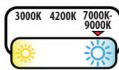
**MARADONA-2**

084-003-0002

Power	:	<b>5 W</b>
Luminous Flux	:	350 lm
Battery	:	4V 6Ah Sealed-Acid
Duration Time	:	4 час / сильный свет 16 часов / слабый свет



RECHARGEABLE

LED TORCH

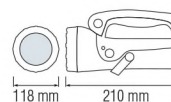

OFF-1-2

**PUSKAS**

- 220-240V / 50-60Hz
- Срок службы 30 000 Часов

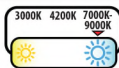
**PUSKAS-2**

084-005-0002

**PUSKAS-3**

084-005-0003

Power	:	<b>0.5 W</b>	<b>0.9 W</b>
Luminous Flux	:	25 lm	45 lm
Battery	:	4V 0.4Ah Sealed-Acid	4V 0.9Ah Sealed-Acid
Duration Time	:	4 Hours	5 Hours
Sizes (mm)	:	A: 75 B: 195	A: 100 B: 210



RECHARGEABLE

LED TORCH

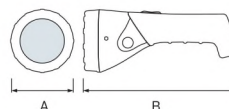

ON-OFF

**BECKHAM**

- 220-240V / 50-60Hz
- Срок службы 30 000 Часов

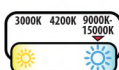
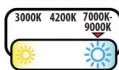

RECHARGEABLE

LED HEADLIGHT

**BECKHAM-1**

084-007-0001

**BECKHAM-3**

084-007-0003

**BECKHAM-4**

084-007-0004

Power	:	<b>1 W (Power LED)</b>	<b>3 W (Power LED)</b>	<b>0.9 W (LED)</b>
Luminous Flux	:	7000-9000K	7000-9000K	9000-15000K
Battery	:	4V 400mAh Sealed-Acid	4V 900mAh Sealed-Acid	4V 900mAh Sealed-Acid
Duration Time	:	1 час / сильный свет 4 часа / слабый свет	1 час / сильный свет 4 часа / слабый свет	1 час / сильный свет 4 часа / слабый свет
Beam Distance	:	20m	30m	20m
Size (mm)	:	A: 70 B: 81 C: 98	A: 85 B: 92 C: 96	A: 85 B: 92 C: 96



1-OFF-2

**HOROZ ELECTRIC****LED аварийные светильники и фонари****MESSI**

- 220-240V / 50-60Hz or 6V DC
- Срок службы 30 000 Часов

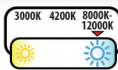
**NEW PRODUCT**

	MESSI-9	MESSI-15	MESSI-23
	084-030-0009	084-030-0015	084-030-0023

Power	: 9 W	15 W	23 W
Luminous Flux	: 280 lm-38 lm	420 lm-70 lm	600 lm-100 lm
Battery	: 4V 1.6Ah Sealed-Acid	2x4V 1.6Ah Sealed-Acid	2x4V 1.6Ah Sealed-Acid
Duration Time	: 3-20 Hours	3-15 Hours	2-10 Hours
Size (mm)	: A: 250 B: 50 C: 50	A: 350 B: 50 C: 50	A: 450 B: 50 C: 50

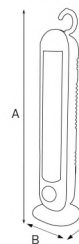

- RECHARGEABLE
- EMERGENCY
- LANTERN

**MALDINI**

- 220-240V / 50-60Hz
- Срок службы 30 000 Часов

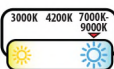

	MALDINI-2	MALDINI-3
	084-014-0002	084-014-0003

Power	: 13 W	16 W
Luminous Flux	: 330 lm	410 lm
Battery	: 2x4V 0.9Ah Sealed-Acid	2x4V 0.9Ah Sealed-Acid
Duration Time	: 3 Hours	3 Hours
Size (mm)	: A: 245 B: 75 C: 45	A: 325 B: 75 C: 45

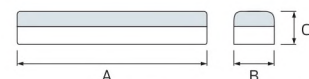

- EMERGENCY EXIT
- SAFETY EMERGENCY
- LANTERN

**WENGER**

- 220-240V / 50-60Hz
- 560 lm
- 4V 3Ah Rechargeable Sealed-Acid Battery
- Время работы: Режим 1: 1 час, Режим 2: 2 час
- Срок службы 30 000 Часов

084 025 0012

RECHARGEABLE

EMERGENCY

LANTERN

**MÜLLER**

084 018 0001

RECHARGEABLE

LED LAMP

E27

- 220-240V / 50-60Hz
- 10x1500 MCD 110° Bright LED Light
- 50 lm
- 4V 0.9Ah Кислотная аккумуляторная батарея
- Время работы: 6 часов
- Автоматическое включение при отсутствии напряжения
- Пост. / Перемен. ток
- Срок службы 30 000 Часов

**ZOFF**

- 220-240V / 50-60Hz
- 50 lm
- 1.2V 600mAh Rechargeable Ni-Cd Battery
- Срок службы 10 000 Часов
- Время работы: 90 минут

084 019 0001

EXIT &amp; SAFETY LAMP

LED LAMP

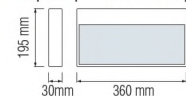
**ROBSON**

084 020 0002

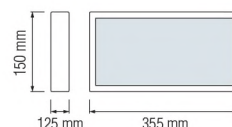

- EMERGENCY
- EXIT & SAFETY
- LED LAMP

- 220-240V / 50-60Hz
- 100 lm
- 1.2V 350mAh Rechargeable Ni-Cd Battery
- Срок службы 20 000 Часов
- Время работы: 120 минут

**HOROZ ELECTRIC**

# Детекторы / Датчики управления светом / Таймеры / Беспроводные переключатели

**Light Control Photosensor****FLASH**

089 001 0001

- Operation Voltage: 220-240V / 50-60Hz
- Ambient Light: <5-15 Lux
- Load Power: 1000W (6A)

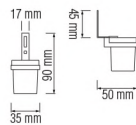
**Light Control Photosensor****FLEX**

089 001 0002

- Operation Voltage: 220-240V / 50-60Hz
- Ambient Light: <50Lux
- Load Power: 1200W (10A)

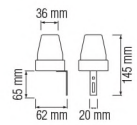
**Light Control Photosensor****LUXOR**

089 001 0003

- Operation Voltage: 220-240V / 50-60Hz
- Ambient Light: <50Lux
- Load Power: 2700W (25A)

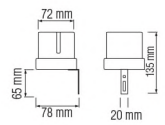
**HOROZ ELECTRIC**

## Детекторы / Датчики управления / Таймеры / Беспроводные переключатели

**TUCSON**

088 001 0009

- Detection Source: 220-240V / AC
- Power Frequency: 50/60Hz
- Rated Load: Max. 800W
- Detection Distance: 12m Max. (<24°C)
- Time Delay: Min. 10sec + 3sec Max. 15min + 2min
- Ambient Light: <3-2000LUX (adjustable)
- Installation Height: 1.8-2.5m
- Detection Motion Speed: 0.6-1.5m/s

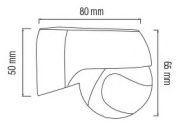
**MEGANE**

088 001 0008

- Operation Voltage: 220-240V / 50-60Hz
- Detection Distance: 12 m Max. (<24°C)
- Time-delay: Min. 10 sec + 3 sec Max. 7 min + 2 min
- Ambient Light: <3 - 2000Lux (adjustable)
- Rated Load: Max. 1200W
- Detection Motion Speed: 0.6-1.5 m/s

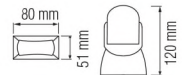
**CORONA**

088 001 0002

- Operation Voltage: 220-240V / 50-60Hz
- Detection Distance: 8 ± 1m Max. (<24°C)
- Time-delay: 5 sec - 10±2 min.
- Ambient Light: <10Lux - 2000Lux
- Rated Load: Max. 1000W

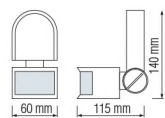

WHITE

BLACK

**LINEA**

088 001 0003

- Operation Voltage: 220-240V / 50-60Hz
- Detection Distance: 8 ± 2 m Max. (<24°C)
- Time-delay: 5 sec - 8±2 min.
- Ambient Light: <10Lux - 2000Lux
- Rated Load: Max. 1000W

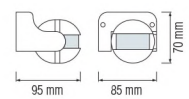

WHITE

BLACK

## FOCUS

088 001 0001

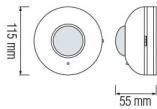

### Specification

- Operation Voltage: 220-240V / 50-60Hz
- Rated Load: Max 1000W
- Detection Distance: 8 ± 1m Max. (-24°C)
- Time-delay: 5 sec - 10±2 min.
- Ambient Light: < 10Lux - 2000Lux

WHITE

BLACK



## MONDEO

088 001 0010

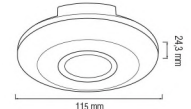

### Specification

- Detection Range: 360°
- Detection Source: 220-240V/AC
- Power Frequency: 50/60Hz
- Rated Load: Max. 800W
- Detection Distance: 6m Max. (-24°C)
- Time Delay: Min. 10sec ± 3sec Max. 15min ± 2min
- Ambient Light: < 3-2000LUX (adjustable)
- Installation Height: 2.2-4m
- Detection Motion Speed: 0.6-1.5m/s



## ROVER

088 001 0011

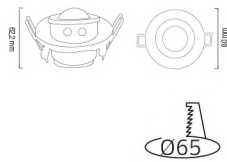

### Specification

- Detection Angle: 360°
- Detection Source: 220-240V/AC
- Power Frequency: 50/60Hz
- Rated Load: Max. 800W
- Detection Distance: 6m Max. (-24°C)
- Time Delay: Min. 10sec ± 3sec Max. 15min ± 2min
- Ambient Light: < 3-2000LUX (adjustable)
- Installation Height: 2.2-4m
- Detection Motion Speed: 0.6-1.5m/s



## CORSA

088 001 0006

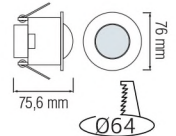

### Specification

- Operation Voltage: 220-240V / 50-60Hz AC
- Rated Load: Max. 1200W
- Detection Distance: 6m Max. (-24°C)
- Time-delay: 10s to 7 min (adjustable)
- Ambient Light: 3Lux / 2000Lux (adjustable)
- Detection Motion Speed: 0.6-1.5m/s
- Installation Height: 2.2-4m



## POLO

088 001 0007

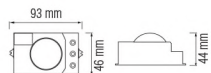

### Specification

- Operation Voltage: 220-240V / 50-60Hz
- Detection Distance: 1-8 m (radius) adjustable
- Time-delay: Min. 10 sec ± 3 sec, Max. 12 min ± 1 min
- Ambient Light: < 3 - 2000Lux (adjustable)
- Rated Load: Max 1200W
- Detection Motion Speed: 0.6-1.5 m/s



## SMART

088 001 0005

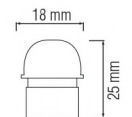

### Specification

- Operation Voltage: 220-240V / 50-60Hz AC
- Rated Load: Max. 1200W
- Detection Distance: 6m Max. (-24°C)
- Time-delay: 10s to 7 min (adjustable)
- Ambient Light: 10Lux / 2000Lux (choice)



Detection is possible to go through doors, panes of glass or thin walls

**HOROZ ELECTRIC**

# Детекторы / Датчики управления светом / Таймеры / Беспроводные переключатели

## CONTROLLER

**Wireless Lighting Controller Switch**

- Working voltage: AC 180-240V 50Hz
- Operation Range: 30m-60m in 360 degree (in open area)
- Tungsten filament lamp≤1000W
- Energy saving lamp/LED≤300W
- Working voltage: 12V(A23 alkaline battery)

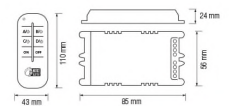
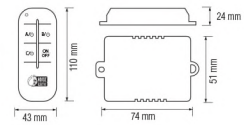
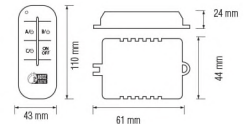
**CONTROLLER-1**

105-001-0001

1 Channel

**CONTROLLER-2**

105-001-0002

2 Channels

**CONTROLLER-3**

105-001-0003

3 Channels

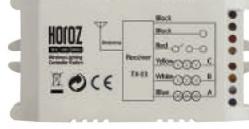
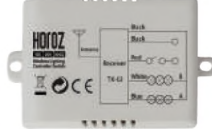
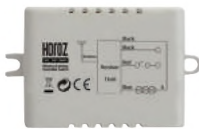

## TIMER

- Working voltage: AC 220-240V 50Hz
- Power: 3500W
- Current: 16A

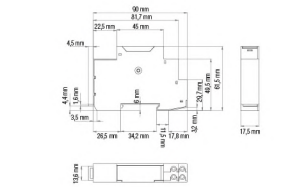
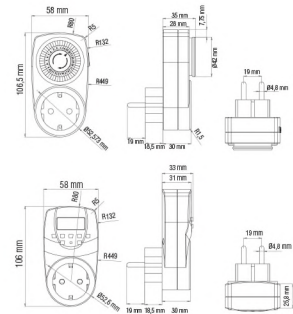

	TIMER-1	TIMER-2	TIMER-3
	108-001-0001	108-002-0001	108-003-0001

Type	: Mechanical Daily	: Digital Weekly	: Mechanical Daily
On/Off Programs	: 24	: 20	: 48
Minimum Setting	: 30 Minutes	: 1 Minute	: 15 Minutes
Power Reserve	: No	: Yes	: Yes

## AXIS

113 001 0001

- Working Voltage: 250V-
- Power: Max.3680W
- Current: 16A
- Child Protection Shutter
- Working signal indicator
- USB O/P: DC 5V, Max 2.1A

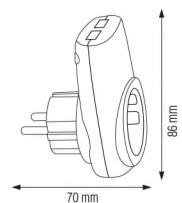
**PLUG IN SWITCH****2 X USB CHARGING SOCKET**





Диммеры /  
Выключатели / Розетки



**HORIZON**

112 006 0001



- 250V-
- DIMMER (10A)
- 400W (Incandescent)
- 300W (LED)

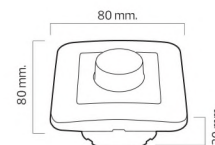

**ATOM**

■ 250V-

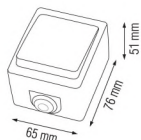

112 100 0004

- ONE WAY SWITCH (10A)

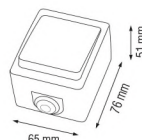

112 100 0007

- TWO WAY SWITCH (10A)

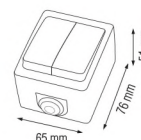

112 100 0006

- 2-GANG ONE WAY SWITCH (10A)

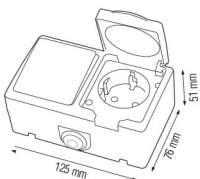

112 100 0003

- 1-GANG GROUNDED SOCKET (16A)
- 1-GANG ONE WAY SWITCH (10A)

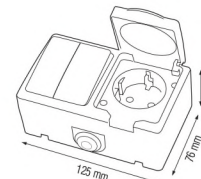

112 100 0005

- 1-GANG GROUNDED SOCKET (16A)
- 2-GANG ONE WAY SWITCH (10A)

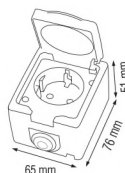

112 100 0001

- GROUNDED SOCKET (16A)

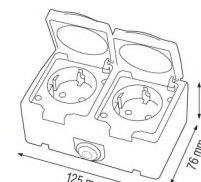

112 100 0002

- 2-GANG GROUNDED SOCKET (16A)





**EVA**

250V~



112 001 0001 ■ ONE WAY SWITCH (10A)

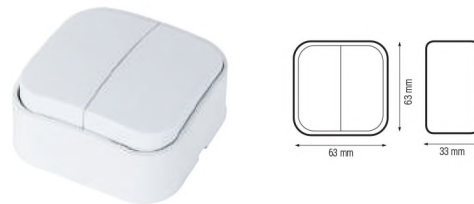

112 001 0003 ■ 2-GANG ONE WAY SWITCH (10A)



112 001 0002 ■ TWO WAY SWITCH (10A)



112 001 0004 ■ PUSH BUTTON (10A)



112 002 0001 ■ ILLUMINATED ONE WAY SWITCH (10A)

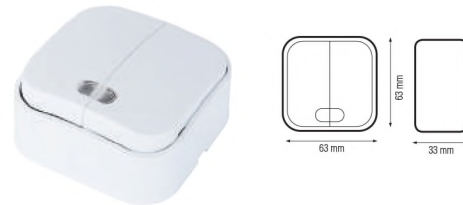

112 002 0002 ■ 2-GANG ILLUMINATED ONE WAY SWITCH (10A)



112 003 0001 ■ SOCKET (16A)



112 003 0002 ■ 2-GANG SOCKET (16A)



112 004 0001 ■ GROUNDED SOCKET (16A)



112 004 0002 ■ 2-GANG GROUNDED SOCKET (16A)



**SAFE**

**MCB Circuit Breaker**

**NEW PRODUCT**

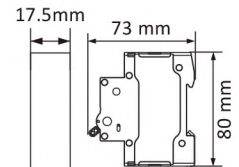

	114-001-1006	114-001-1010	114-001-1016	114-001-1020	114-001-1025	114-001-1032	114-001-1040	114-002-1002	114-002-1004	114-002-1050	114-002-1063
Rated Current (A)	6A	10A	16A	20A	25A	32A	40A	2A	4A	50A	63A
Poles	1 Pole	1 Pole	1 Pole	1 Pole	1 Pole	1 Pole	1 Pole	1 Pole	1 Pole	1 Pole	1 Pole
Instantaneous tripping type	B	B	B	B	B	B	B	C	C	C	C
Rated short-circuit breaking capacity (kA)	4.5kA	4.5kA	4.5kA	4.5kA	4.5kA	4.5kA	4.5kA	4.5kA	4.5kA	4.5kA	4.5kA
Rated working voltage(V)	230V/400V	230V/400V	230V/400V	230V/400V	230V/400V	230V/400V	230V/400V	230V/400V	230V/400V	230V/400V	230V/400V

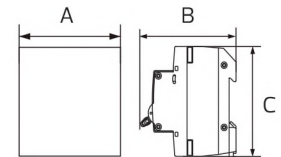
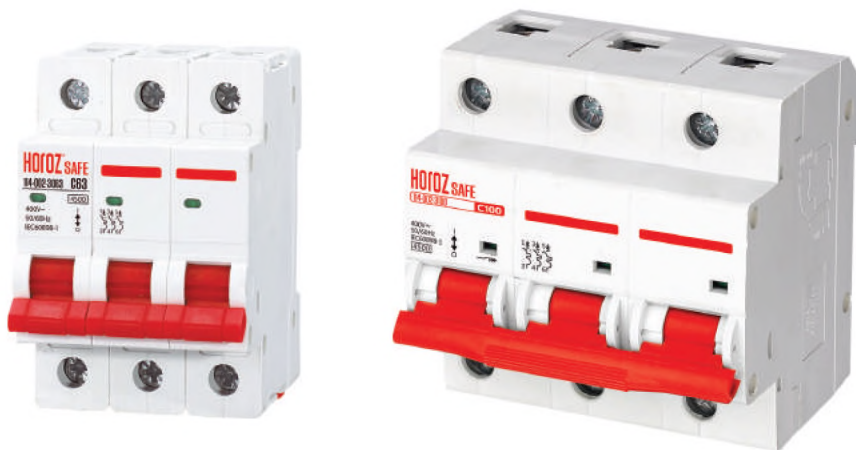

	114-002-3006	114-002-3010	114-002-3016	114-002-3020	114-002-3025	114-002-3032	114-002-3040	114-002-3050	114-002-3063	114-002-3080	114-002-3100
Rated Current (A)	6A	10A	16A	20A	25A	32A	40A	50A	63A	80A	100A
Poles	3 Pole	3 Pole	3 Pole	3 Pole	3 Pole	3 Pole	3 Pole	3 Pole	3 Pole	3 Pole	3 Pole
Instantaneous tripping type	C	C	C	C	C	C	C	C	C	C	C
Rated short-circuit breaking capacity (kA)	4.5kA	4.5kA	4.5kA	4.5kA	4.5kA	4.5kA	4.5kA	4.5kA	4.5kA	4.5kA	4.5kA
Rated working voltage(V)	400V	400V	400V	400V	400V	400V	400V	400V	400V	400V	400V
Sizes (mm)	A: 52.5 B: 73 C: 80	A: 52.5 B: 73 C: 80	A: 52.5 B: 73 C: 80	A: 52.5 B: 73 C: 80	A: 52.5 B: 73 C: 80	A: 52.5 B: 73 C: 80	A: 52.5 B: 73 C: 80	A: 52.5 B: 73 C: 80	A: 52.5 B: 73 C: 80	A: 80.7 B: 73 C: 80	A: 80.7 B: 73 C: 80

**SAFE**

### RCCB Circuit Breaker



	114-003-2025	114-003-2040	114-003-4025	114-003-4040	114-003-4063	114-003-4080	114-003-4100
Rated Current (A)	25A	40A	25A	40A	63A	80A	100A
Poles	2 Pole	2 Pole	4 Pole	4 Pole	4 Pole	4 Pole	4 Pole
Instantaneous tripping type	AC	AC	AC	AC	AC	AC	AC
Rated short-circuit breaking capacity (kA)	4.5kA	4.5kA	4.5kA	4.5kA	4.5kA	4.5kA	4.5kA
Rated working voltage(V)	230V	230V	400V	400V	400V	400V	400V
Rated Residual Current(mA)	30	30	30	30	30	30	30
Sizes (mm)	A: 35 B: 80 C: 73	A: 35 B: 80 C: 73	A: 70 B: 80 C: 73	A: 70 B: 80 C: 73	A: 70 B: 80 C: 73	A: 72 B: 81 C: 74	A: 72 B: 81 C: 74

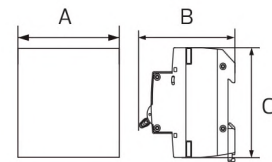

**SAFE**

### MCCB Circuit Breaker



	114-004-3040	114-004-3050	114-004-3063	114-004-3100	114-004-3125	114-004-3160	114-004-3200	114-004-3250
Rated Current (A)	40A	50A	63A	100A	125A	160A	200A	250A
Poles	3 Pole	3 Pole	3 Pole	3 Pole	3 Pole	3 Pole	3 Pole	3 Pole
Instantaneous tripping type	C	C	C	C	C	C	C	C
Rated short-circuit breaking capacity (kA)	20kA	20kA	20kA	35kA	35kA	35kA	35kA	35kA
Rated working voltage(V)	400V	400V	400V	400V	400V	400V	400V	400V
Sizes (mm)	A: 135 B: 78 C: 74	A: 135 B: 78 C: 74	A: 135 B: 78 C: 74	A: 150 B: 92 C: 69	A: 150 B: 92 C: 69	A: 165 B: 101 C: 86	A: 165 B: 101 C: 86	A: 165 B: 101 C: 86

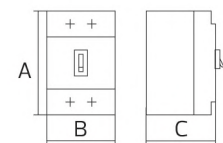



Патроны



094 004 0001

10 cm.

20 cm.

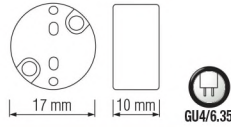

094 004 0002

15 cm.

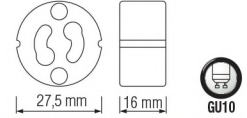

094 001 0001

BAKELITE

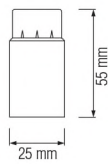

094 001 0002

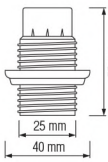

094 001 0003

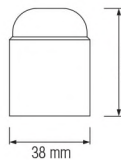

094 001 0004

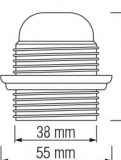

094 002 0001

PLASTIC

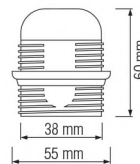

094 002 0002

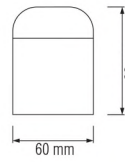

094 002 0003

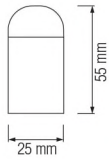

094 002 0004

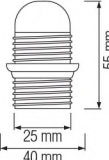

094 003 0001

PORCELAIN

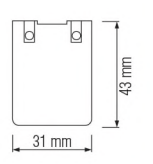

094 003 0002

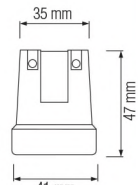

094 003 0003

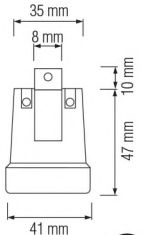

094 003 0004

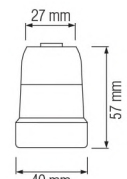



**HOROZ ELECTRIC**

# Стартеры / Клипсы / Соединители / Кабель / Клеммы / Изолента

## Starter S10

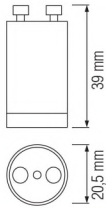

	S2	S10
220-240V SINGLE :	4-22W	4-65W
220-240V SERIES :	4-22W	-
110-130V SINGLE :	4-22W	-

## TRANSFORMER

■ 220-240V / 50-60Hz  
■ 12V AC

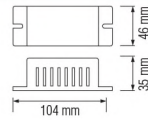

	TRANSFORMER-60	TRANSFORMER-105	TRANSFORMER-150
	093-001-0060	093-001-0105	093-001-0150
Power :	60 W	105 W	150 W



**HOROZ ELECTRIC**

# Стартеры / Клипсы / Соединители / Кабель / Клеммы / Изолента



## ADHESIVE TAPE

- WHITE
- YELLOW
- RED
- BLUE
- GREEN
- BLACK
- GREEN - YELLOW



■ 10 YARDS

■ 20 YARDS

## NAIL CABLE CLIP



CIRCLE	NAIL
4 mm	1.7 x 15
5 mm	1.7 x 15
6 mm	1.7 x 17
7 mm	1.8 x 19
8 mm	1.9 x 21
9 mm	2.0 x 22
10 mm	2.05 x 25
12 mm	2.05 x 27
14 mm	2.4 x 32
16 mm	2.5 x 35
18 mm	2.5 x 37
22 mm	2.8 x 48

## CABLE TIE



■ 2,5*100	■ 7,2*300
■ 2,5*150	■ 7,2*350
■ 2,5*200	■ 7,2*400
■ 3,6*150	■ 7,2*450
■ 3,6*200	■ 9*550
■ 3,6*250	■ 9*650
■ 3,6*280	■ 9*750
■ 3,6*300	■ 9*1020
■ 3,6*370	
■ 4,8*200	
■ 4,8*250	
■ 4,8*300	
■ 4,8*350	
■ 4,8*370	
■ 4,8*400	

## RG6

COAXIAL CABLE  
100m ROLL



6,8 PVC | 64x0,12 AL. BRAIDING | AL. FOIL BONDED | 4,8 FPE | 1,02 CCS

## UTP

■ NETWORK CABLE  
305m ROLL

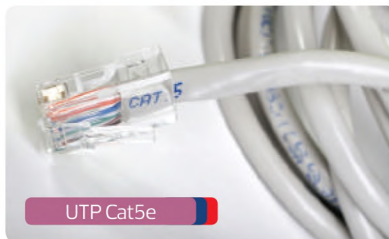

UTP Cat5e

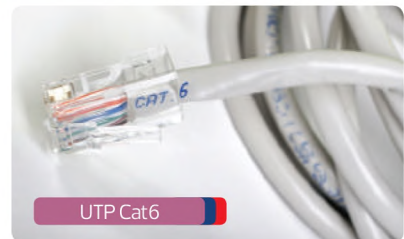

UTP Cat6

**HOROZ ELECTRIC**

Соединители / Клеммы / Удлинители

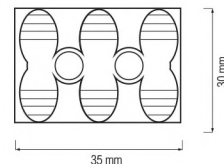
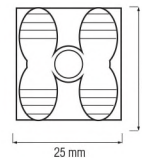
**WIRE SPRING**

	WIRE SPRING-2/15 106-002-0015	WIRE SPRING-2/25 106-002-0025	WIRE SPRING-2/6 106-002-0060	WIRE SPRING-3/15 106-003-0015	WIRE SPRING-3/25 106-003-0025	WIRE SPRING-3/6 106-003-0060
Pole	2 Pole	2 Pole	2 Pole	3 Pole	3 Pole	3 Pole
Cable Diameter	0,2-1,5 mm <sup>2</sup>	0,5-2,5 mm <sup>2</sup>	1,5-6,0 mm <sup>2</sup>	0,2-1,5 mm <sup>2</sup>	0,5-2,5 mm <sup>2</sup>	1,5-6,0 mm <sup>2</sup>
Current / Voltage	5A/380V	10A/380V	25A/380V	5A/380V	10A/380V	25A/380V

**HOROZ ELECTRIC**

Соединители / Клеммы

**TERMINAL BLOCK**

- 60 A, 25 mm<sup>2</sup>
- 30 A, 16 mm<sup>2</sup>
- 10 A, 10 mm<sup>2</sup>
- 5 A, 6 mm<sup>2</sup>
- 3 A, 4 mm<sup>2</sup>

**CONNECTOR**

- 400V/4kV-
- Max. 32A
- Wire Range: 0.08 - 4 mm<sup>2</sup>
- Wiring Type: Spring Clamping 28-10AWG



	CONNECTOR-2 103-001-0002	CONNECTOR-3 103-001-0003	CONNECTOR-5 103-001-0005
--	-----------------------------	-----------------------------	-----------------------------

Pole	2 Pole	3 Pole	5 Pole
------	--------	--------	--------

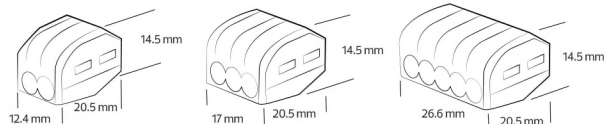
**HOROZ ELECTRIC**

Удлинители

**REEL**

- 230V~/50-60Hz
- Max. 3000W
- Max. 13.04A
- 3x1.5 mm<sup>2</sup>
- 4 Sockets
- Overload Protection

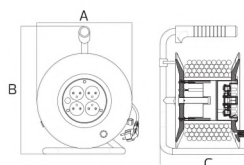

	REEL-15 104-006-0015	REEL-25 104-006-0025	REEL-50 104-006-0050	EMPTY-25 104-007-0025
--	-------------------------	-------------------------	-------------------------	--------------------------

Cable Length	15 Meters	25 Meters	50 Meters	Max. 25 Meters
Sizes (mm)	A: 200 B: 260 C: 150	A: 215 B: 314 C: 170	A: 265 B: 345 C: 210	A: 230 B: 310 C: 195



Türkiye



Произведено в Турции

KaçmazGrup



İkili Two  
 Üçlü Three  
 Dörtlü Four  
 Altılı Six

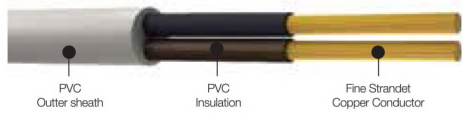
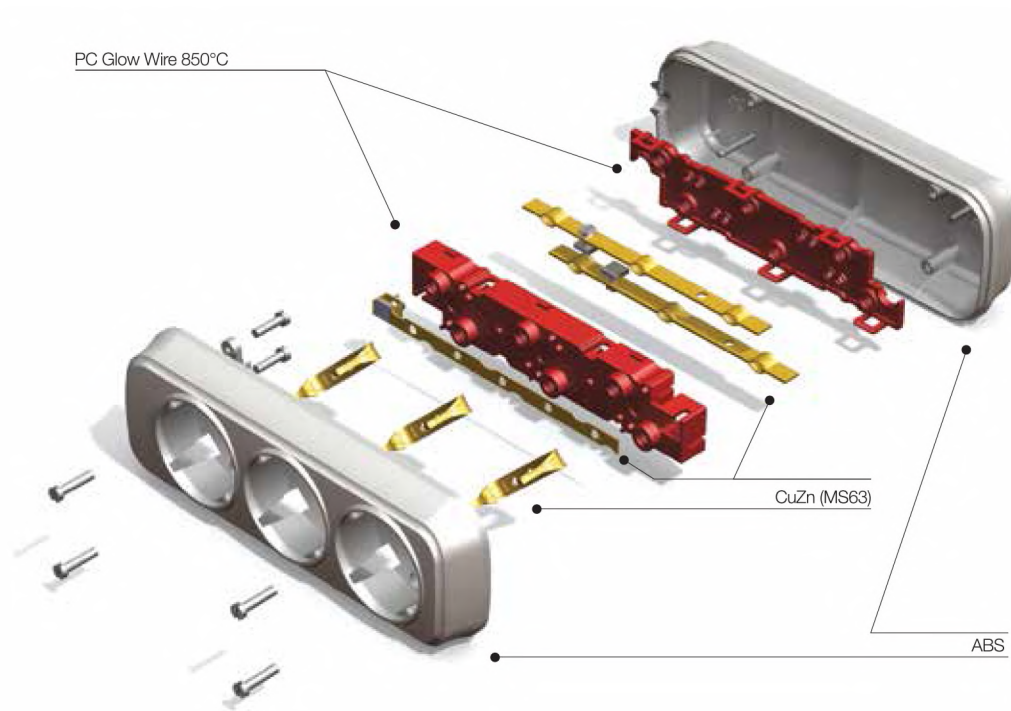

Cross Section	Overall Diameter	Conductor mm	Conductor PCS
2 x 0.75 mm <sup>2</sup>	6.4 mm	0.19	24
3 x 1 mm <sup>2</sup>	7.2 mm	0.19	32
3 x 1.5 mm <sup>2</sup>	8.5 mm	0.24	30



**TOPRAKLI 2'Lİ GRUP PRİZ / GROUNDED 2 GANG SOCKET**  
**/ КОЛОДКИ НА 2 ГНЕЗДА С/З**



**200-200-201**

Quantity in Box	1	250V~50-60Hz 16A
Quantity in Carton	36	
Carton (N/G) Weight Kg.	3,12 / 3,50	
Carton m <sup>3</sup>	0,013	



**200-202-201**

**2 M.**

Quantity in Box	1	250V~50-60Hz 16A
Quantity in Carton	12	
Carton (N/G) Weight Kg.	3,55 / 3,85	
Carton m <sup>3</sup>	0,015	



**200-203-201**

**3 M.**

Quantity in Box	1	250V~50-60Hz 16A
Quantity in Carton	12	
Carton (N/G) Weight Kg.	4,60 / 4,97	
Carton m <sup>3</sup>	0,015	



**200-205-201**

**5 M.**

Quantity in Box	1	250V~50-60Hz 16A
Quantity in Carton	12	
Carton (N/G) Weight Kg.	6,61 / 6,98	
Carton m <sup>3</sup>	0,018	



**200-207-201**

**7 M.**

Quantity in Box	1	250V~50-60Hz 16A
Quantity in Carton	12	
Carton (N/G) Weight Kg.	9,33 / 9,70	
Carton m <sup>3</sup>	0,023	



**200-210-201**

**10 M.**

Quantity in Box	1	250V~50-60Hz 16A
Quantity in Carton	12	
Carton (N/G) Weight Kg.	12,53 / 12,90	
Carton m <sup>3</sup>	0,028	



**TOPRAKLI 3'LÜ GRUP PRİZ / GROUNDED 3 GANG SOCKET**  
**КОЛОДКИ НА 3 ГНЕЗДА C/З**



**200-300-301**

Quantity in Box	1	250V~50-60Hz 16A
Quantity in Carton	36	
Carton (N/G) Weight Kg.	4,01 / 4,5	
Carton m <sup>3</sup>	0,019	



**200-302-301**

**2 M.**

Quantity in Box	1	250V~50-60Hz 16A
Quantity in Carton	12	
Carton (N/G) Weight Kg.	3,83 / 4,19	
Carton m <sup>3</sup>	0,015	



**200-303-301**

**3 M.**

Quantity in Box	1	250V~50-60Hz 16A
Quantity in Carton	12	
Carton (N/G) Weight Kg.	4,79 / 5,15	
Carton m <sup>3</sup>	0,015	



**200-305-301**

**5 M.**

Quantity in Box	1	250V~50-60Hz 16A
Quantity in Carton	12	
Carton (N/G) Weight Kg.	7,01 / 7,38	
Carton m <sup>3</sup>	0,018	



**200-307-301**

**7 M.**

Quantity in Box	1	250V~50-60Hz 16A
Quantity in Carton	12	
Carton (N/G) Weight Kg.	9,46 / 9,82	
Carton m <sup>3</sup>	0,023	



**200-310-301**

**10 M.**

Quantity in Box	1	250V~50-60Hz 16A
Quantity in Carton	12	
Carton (N/G) Weight Kg.	10,03 / 10,39	
Carton m <sup>3</sup>	0,028	



**TOPRAKLI 3'LÜ ANAHTARLI GRUP PRİZ /  
GROUNDED 3-GANG SOCKET WITH TERMINALS AND SWITCH /  
КОЛОДКИ НА 3 ГНЕЗДА С/З С ВЫКЛЮЧАТЕЛЕМ**



**200-300-302**

Quantity in Box	1	250V~50-60Hz 16A
Quantity in Carton	36	
Carton (N/G) Weight Kg.	4,95 / 5,47	
Carton m <sup>3</sup>	0,025	



**200-302-302**

**2 M.**

Quantity in Box	1	250V~50-60Hz 16A
Quantity in Carton	12	
Carton (N/G) Weight Kg.	4,23 / 4,67	
Carton m <sup>3</sup>	0,018	



**200-303-302**

**3 M.**

Quantity in Box	1	250V~50-60Hz 16A
Quantity in Carton	12	
Carton (N/G) Weight Kg.	5,30 / 5,67	
Carton m <sup>3</sup>	0,018	



**200-305-302**

**5 M.**

Quantity in Box	1	250V~50-60Hz 16A
Quantity in Carton	12	
Carton (N/G) Weight Kg.	7,11 / 7,57	
Carton m <sup>3</sup>	0,018	



**200-307-302**

**7 M.**

Quantity in Box	1	250V~50-60Hz 16A
Quantity in Carton	12	
Carton (N/G) Weight Kg.	10,06 / 10,42	
Carton m <sup>3</sup>	0,028	



**200-310-302**

**10 M.**

Quantity in Box	1	250V~50-60Hz 16A
Quantity in Carton	12	
Carton (N/G) Weight Kg.	13,30 / 13,88	
Carton m <sup>3</sup>	0,028	



**TOPRAKLI 4'LÜ GRUP PRİZ /**  
**GROUNDED 4-GANG SOCKET / КОЛОДКИ НА 4 ГНЕЗДА С/З**



**200-400-401**

Quantity in Box	1	<b>250V~50-60Hz 16A</b>
Quantity in Carton	36	
Carton (N/G) Weight Kg.	5,13 / 5,65	
Carton m <sup>3</sup>	0,025	



**200-402-401**

**2 M.**

Quantity in Box	1	<b>250V~50-60Hz 16A</b>
Quantity in Carton	12	
Carton (N/G) Weight Kg.	4,36 / 4,67	
Carton m <sup>3</sup>	0,018	



**200-403-401**

**3 M.**

Quantity in Box	1	<b>250V~50-60Hz 16A</b>
Quantity in Carton	12	
Carton (N/G) Weight Kg.	5,29 / 5,66	
Carton m <sup>3</sup>	0,018	



**200-405-401**

**5 M.**

Quantity in Box	1	<b>250V~50-60Hz 16A</b>
Quantity in Carton	12	
Carton (N/G) Weight Kg.	7,32 / 7,77	
Carton m <sup>3</sup>	0,018	



**200-407-401**

**7 M.**

Quantity in Box	1	<b>250V~50-60Hz 16A</b>
Quantity in Carton	12	
Carton (N/G) Weight Kg.	10,10 / 10,46	
Carton m <sup>3</sup>	0,028	



**200-410-401**

**10 M.**

Quantity in Box	1	<b>250V~50-60Hz 16A</b>
Quantity in Carton	12	
Carton (N/G) Weight Kg.	13,34 / 14,04	
Carton m <sup>3</sup>	0,028	



**TOPRAKLI 4'LÜ ANAHTARLI GRUP PRİZ /  
GROUNDED 4-GANG SOCKET WITH TERMINALS AND SWITCH /  
КОЛОДКИ НА 4 ГНЕЗДА С/З С ВЫКЛЮЧАТЕЛЕМ**



**200-400-402**

Quantity in Box	1	250V~50-60Hz 16A
Quantity in Carton	36	
Carton (N/G) Weight Kg.	6,26 / 6,81	
Carton m <sup>3</sup>	0,030	



**200-402-402**

**2 M.**

Quantity in Box	1	250V~50-60Hz 16A
Quantity in Carton	12	
Carton (N/G) Weight Kg.	4,56 / 5,03	
Carton m <sup>3</sup>	0,023	



**200-403-402**

**3 M.**

Quantity in Box	1	250V~50-60Hz 16A
Quantity in Carton	12	
Carton (N/G) Weight Kg.	5,67 / 6,12	
Carton m <sup>3</sup>	0,023	



**200-405-402**

**5 M.**

Quantity in Box	1	250V~50-60Hz 16A
Quantity in Carton	12	
Carton (N/G) Weight Kg.	7,68 / 8,13	
Carton m <sup>3</sup>	0,023	



**200-407-402**

**7 M.**

Quantity in Box	1	250V~50-60Hz 16A
Quantity in Carton	12	
Carton (N/G) Weight Kg.	10,29 / 10,74	
Carton m <sup>3</sup>	0,028	



**200-410-402**

**10 M.**

Quantity in Box	1	250V~50-60Hz 16A
Quantity in Carton	12	
Carton (N/G) Weight Kg.	13,91 / 14,62	
Carton m <sup>3</sup>	0,028	



**TOPRAKLI 6'LI GRUP PRİZ /**  
**GROUNDING 4-GANG SOCKET / КОЛОДКИ НА 6 ГНЉЗД С/З**



**200-600-601**

Quantity in Box	1	<b>250V~50-60Hz 16A</b>
Quantity in Carton	36	
Carton (N/G) Weight Kg.	7,62 / 8,33	
Carton m <sup>3</sup>	0,037	



**200-602-601**

**2 M.**

Quantity in Box	1	<b>250V~50-60Hz 16A</b>
Quantity in Carton	12	
Carton (N/G) Weight Kg.	5,26 / 5,85	
Carton m <sup>3</sup>	0,028	



**200-603-601**

**3 M.**

Quantity in Box	1	<b>250V~50-60Hz 16A</b>
Quantity in Carton	12	
Carton (N/G) Weight Kg.	6,17 / 6,85	
Carton m <sup>3</sup>	0,028	



**200-605-601**

**5 M.**

Quantity in Box	1	<b>250V~50-60Hz 16A</b>
Quantity in Carton	12	
Carton (N/G) Weight Kg.	8,31 / 8,89	
Carton m <sup>3</sup>	0,028	



**200-607-601**

**7 M.**

Quantity in Box	1	<b>250V~50-60Hz 16A</b>
Quantity in Carton	12	
Carton (N/G) Weight Kg.	10,91 / 11,49	
Carton m <sup>3</sup>	0,028	



**200-610-601**

**10 M.**

Quantity in Box	1	<b>250V~50-60Hz 16A</b>
Quantity in Carton	12	
Carton (N/G) Weight Kg.	14,25 / 14,83	
Carton m <sup>3</sup>	0,037	



**TOPRAKLI 6'LI ANAHTARLI GRUP PRİZ /  
GROUNDED 6-GANG SOCKET WITH TERMINALS AND SWITCH /  
КОЛОДКИ НА 6 ГНЁЗД С/З С ВЫКЛЮЧАТЕЛЕМ**



**200-600-602**

Quantity in Box	1	250V~50-60Hz 16A
Quantity in Carton	36	
Carton (N/G) Weight Kg.	8,9 / 9,61	
Carton m <sup>3</sup>	0,037	



**200-602-602**

**2 M.**

Quantity in Box	1	250V~50-60Hz 16A
Quantity in Carton	12	
Carton (N/G) Weight Kg.	5,49 / 6,07	
Carton m <sup>3</sup>	0,028	



**200-603-602**

**3 M.**

Quantity in Box	1	250V~50-60Hz 16A
Quantity in Carton	12	
Carton (N/G) Weight Kg.	6,56 / 7,14	
Carton m <sup>3</sup>	0,028	



**200-605-602**

**5 M.**

Quantity in Box	1	250V~50-60Hz 16A
Quantity in Carton	12	
Carton (N/G) Weight Kg.	8,56 / 9,14	
Carton m <sup>3</sup>	0,028	



**200-607-602**

**7 M.**

Quantity in Box	1	250V~50-60Hz 16A
Quantity in Carton	12	
Carton (N/G) Weight Kg.	11,19 / 11,77	
Carton m <sup>3</sup>	0,028	



**200-610-602**

**10 M.**

Quantity in Box	1	250V~50-60Hz 16A
Quantity in Carton	12	
Carton (N/G) Weight Kg.	14,49 / 15,07	
Carton m <sup>3</sup>	0,037	





**TOPRAKSIZ 2'Lİ GRUP PRİZ /**  
**UNGROUNDED 2-GANG SOCKET / КОЛОДКИ НА 2 ГНЕЗДА Б/З**



**200-200-203**

Quantity in Box	1	250V~50-60Hz 10A
Quantity in Carton	36	
Carton (N/G) Weight Kg.	2,29 / 2,67	
Carton m <sup>3</sup>	0,013	



**200-202-203**

**2 M.**

Quantity in Box	1	250V~50-60Hz 10A
Quantity in Carton	12	
Carton (N/G) Weight Kg.	2,49 / 2,87	
Carton m <sup>3</sup>	0,015	



**200-203-203**

**3 M.**

Quantity in Box	1	250V~50-60Hz 10A
Quantity in Carton	12	
Carton (N/G) Weight Kg.	3,23 / 3,61	
Carton m <sup>3</sup>	0,015	



**200-205-203**

**5 M.**

Quantity in Box	1	250V~50-60Hz 10A
Quantity in Carton	12	
Carton (N/G) Weight Kg.	4,81 / 5,19	
Carton m <sup>3</sup>	0,015	



**200-207-203**

**7 M.**

Quantity in Box	1	250V~50-60Hz 10A
Quantity in Carton	12	
Carton (N/G) Weight Kg.	7,01 / 7,74	
Carton m <sup>3</sup>	0,023	



**200-210-203**

**10 M.**

Quantity in Box	1	250V~50-60Hz 10A
Quantity in Carton	12	
Carton (N/G) Weight Kg.	8,31 / 9,04	
Carton m <sup>3</sup>	0,023	



**TOPRAKSIZ 3'LÜ GRUP PRİZ /**  
**UNGROUNDED 3-GANG SOCKET / КОЛОДКИ НА 3 ГНЕЗДА Б/З**



**200-300-303**

Quantity in Box	1	<b>250V~50-60Hz 10A</b>
Quantity in Carton	36	
Carton (N/G) Weight Kg.	3,2 / 3,6	
Carton m <sup>3</sup>	0,018	



**200-302-303**

**2 M.**

Quantity in Box	1	<b>250V~50-60Hz 10A</b>
Quantity in Carton	12	
Carton (N/G) Weight Kg.	2,89 / 3,25	
Carton m <sup>3</sup>	0,015	



**200-303-303**

**3 M.**

Quantity in Box	1	<b>250V~50-60Hz 10A</b>
Quantity in Carton	12	
Carton (N/G) Weight Kg.	3,03 / 3,4	
Carton m <sup>3</sup>	0,015	



**200-305-303**

**5 M.**

Quantity in Box	1	<b>250V~50-60Hz 10A</b>
Quantity in Carton	12	
Carton (N/G) Weight Kg.	5,24 / 5,6	
Carton m <sup>3</sup>	0,015	



**200-307-303**

**7 M.**

Quantity in Box	1	<b>250V~50-60Hz 10A</b>
Quantity in Carton	12	
Carton (N/G) Weight Kg.	7,27 / 7,63	
Carton m <sup>3</sup>	0,023	



**200-310-303**

**10 M.**

Quantity in Box	1	<b>250V~50-60Hz 10A</b>
Quantity in Carton	12	
Carton (N/G) Weight Kg.	8,95 / 9,31	
Carton m <sup>3</sup>	0,023	



**TOPRAKSIZ 4'LÜ GRUP PRİZ /**  
**UNGROUNDED 4-GANG SOCKET / КОЛОДКИ НА 4 ГНЕЗДА Б/З**



**200-400-403**

Quantity in Box	1	250V~50-60Hz 10A
Quantity in Carton	36	
Carton (N/G) Weight Kg.	4,02 / 4,5	
Carton m <sup>3</sup>	0,020	



**200-402-403**

**2 M.**

Quantity in Box	1	250V~50-60Hz 10A
Quantity in Carton	12	
Carton (N/G) Weight Kg.	3,23 / 3,59	
Carton m <sup>3</sup>	0,015	



**200-403-403**

**3 M.**

Quantity in Box	1	250V~50-60Hz 10A
Quantity in Carton	12	
Carton (N/G) Weight Kg.	3,92 / 4,3	
Carton m <sup>3</sup>	0,015	



**200-405-403**

**5 M.**

Quantity in Box	1	250V~50-60Hz 10A
Quantity in Carton	12	
Carton (N/G) Weight Kg.	5,51 / 5,87	
Carton m <sup>3</sup>	0,015	



**200-407-403**

**7 M.**

Quantity in Box	1	250V~50-60Hz 10A
Quantity in Carton	12	
Carton (N/G) Weight Kg.	7,51 / 7,96	
Carton m <sup>3</sup>	0,023	



**200-410-403**

**10 M.**

Quantity in Box	1	250V~50-60Hz 10A
Quantity in Carton	12	
Carton (N/G) Weight Kg.	10,01 / 10,72	
Carton m <sup>3</sup>	0,023	

## Plugs

Fişler  
Uzatma Takımı

Extension Kit

Golyad  
Arapuar

Golyad

Adaptör Fiş

Hand Switch

Adaptor Plug

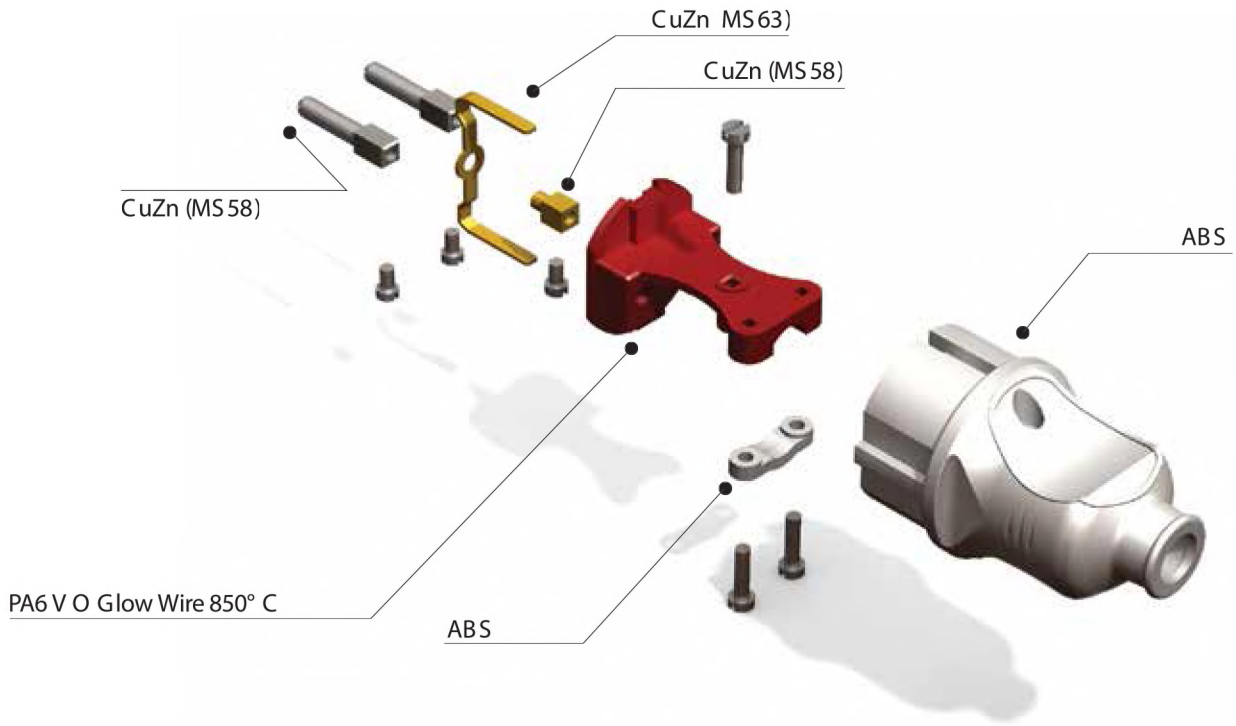

**TOPRAKLI ERKEK FİŞ**

GROUNDED MALE PLUG

ВИЛКА С/З

**300-000-702**

Quantity in Box	50	250V~50-60Hz 16A
Quantity in Carton	400	
Carton (N/G) Weight Kg.	13,56 / 14,3	
Carton m <sup>3</sup>	0,052	

**TOPRAKLI DiŞİ FİŞ**

GROUNDED FEMALE PLUG

ШТЕПСЕЛЬНОЕ ГНЕЗДО С/З

**300-000-706**

Quantity in Box	36	250V~50-60Hz 16A
Quantity in Carton	288	
Carton (N/G) Weight Kg.	12,42 / 13,3	
Carton m <sup>3</sup>	0,052	

**KULPLU TOPRAKLI ERKEK FİŞ**

GROUNDED MALE PLUG WITH HANDLE

ВИЛКА УГЛОВАЯ С УШКОМ С/З

**300-000-703**

Quantity in Box	45	250V~50-60Hz 16A
Quantity in Carton	360	
Carton (N/G) Weight Kg.	12,8 / 13,5	
Carton m <sup>3</sup>	0,052	

**TOPRAKLI L TİPİ FİŞ**

GROUNDED L TYPE PLUG

ВИЛКА УГЛОВАЯ С/З

**300-000-704**

Quantity in Box	50	250V~50-60Hz 16A
Quantity in Carton	400	
Carton (N/G) Weight Kg.	13,0 / 13,75	
Carton m <sup>3</sup>	0,052	

**TOPRAKSIZ ERKEK FIŞ**

UNGROUNDING MALE PLUG

ВИЛКА Б/З

**300-000-701**

Quantity in Box	100	250V~50-60Hz 10A
Quantity in Carton	800	
Carton (N/G) Weight Kg.	18,6 / 19,3	
Carton m <sup>3</sup>	0,052	

**TOPRAKSIZ DIŞI FIŞ**

UNGROUNDING FEMALE PLUG

ШТЕПСЕЛЬНОЕ ГНЕЗДО Б/З

**300-000-705**

Quantity in Box	50	250V~50-60Hz 10A
Quantity in Carton	400	
Carton (N/G) Weight Kg.	13,83 / 15,30	
Carton m <sup>3</sup>	0,052	

**ADAPTÖR FIŞ**

ADAPTOR PLUG

ВИЛКА ПЕРЕХОДНИК

**300-000-803**

Quantity in Box	90	250V~50-60Hz 10A
Quantity in Carton	720	
Carton (N/G) Weight Kg.	12,89 / 13,65	
Carton m <sup>3</sup>	0,052	

**İŞIKLI ANAHTAR**

ROCKERSWITCH

ВЫКЛЮЧАТЕЛЬ

**300-000-709**

Quantity in Box	150	250V~50-60Hz 16A
Quantity in Carton	1200	
Carton (N/G) Weight Kg.	20,5 / 22	
Carton m <sup>3</sup>	0,052	

**KAUÇUK TOPRAKLI ERKEK FİŞ**

GROUNDED RUBBER MALE PLUG

КАУЧУКОВАЯ ВИЛКА С/З

**300-000-804**

Quantity in Box	40	250V~50-60Hz 16A
Quantity in Carton	320	
Carton (N/G) Weight Kg.	12,17 / 13,65	
Carton m <sup>3</sup>	0,052	

**KAUÇUK TOPRAKLI DİŞİ FİŞ**

GROUNDED RUBBER FEMALE PLUG

КАУЧУКОВОЕ ШТЕПСЕЛЬНОЕ ГНЕЗДО С/З

**300-000-805**

Quantity in Box	25	250V~50-60Hz 16A
Quantity in Carton	200	
Carton (N/G) Weight Kg.	9,62 / 11,11	
Carton m <sup>3</sup>	0,052	

**ARAPUAR**

HAND SWITCH

ВЫКЛЮЧАТЕЛЬ ДЛЯ БРА

SİYAH-KIRMIZI / RED-BLACK  
КРАСНЫЙ-ЧЕРНЫЙ**300-003-708**

Quantity in Box	120	250V~50-60Hz 10A
Quantity in Carton	960	
Carton (N/G) Weight Kg.	18,03 / 19,50	
Carton m <sup>3</sup>	0,052	

BEYAZ-KIRMIZI / RED-WHITE  
КРАСНЫЙ-БЕЛЫЙ**300-002-708**BEYAZ-BEYAZ / WHITE  
БЕЛЫЙ**300-001-708**

**TOPRAKLI 3'LÜ FİŞ PRİZ (GOLYAD)**

GROUNDED 3 GANG PLUG SOCKED (GOLYAD)

ТРОЙНАЯ РОЗЕТКА С/З (GOLYAD)

**300-000-707**

Quantity in Box	1	250V~50-60Hz 16A
Quantity in Carton	40	
Carton (N/G) Weight Kg.	4,02 / 4,56	
Carton m <sup>3</sup>	0,025	

**TOPRAKSIZ 3'LÜ FİŞ PRİZ (GOLYAD)**

UNGROUNDED 3 GANG PLUG SOCKED (GOLYAD)

ТРОЙНАЯ РОЗЕТКА Б/З (GOLYAD)

**300-000-802**

Quantity in Box	1	250V~50-60Hz 10A
Quantity in Carton	40	
Carton (N/G) Weight Kg.	2,31 / 2,81	
Carton m <sup>3</sup>	0,025	





**TOPRAKLI UZATMA TAKIMI**

GROUNDING EXTENSION KIT

УДЛИНИТЕЛЬ КАБЕЛЯ С/З



**300-003-801**

**3 M.**

Quantity in Box	1	250V~50-60Hz 16A
Quantity in Carton	12	
Carton (N/G) Weight Kg.	4,33 / 4,80	
Carton m <sup>3</sup>	0,015	



**300-005-801**

**5 M.**

Quantity in Box	1	250V~50-60Hz 16A
Quantity in Carton	12	
Carton (N/G) Weight Kg.	6,37 / 6,84	
Carton m <sup>3</sup>	0,018	

**TOPRAKSIZ UZATMA TAKIMI**

UNGROUNDING EXTENSION KIT

УДЛИНИТЕЛЬ КАБЕЛЯ Б/З



**300-003-800**

**3 M.**

Quantity in Box	1	250V~50-60Hz 10A
Quantity in Carton	12	
Carton (N/G) Weight Kg.	3,16 / 3,63	
Carton m <sup>3</sup>	0,015	



**300-005-800**

**5 M.**

Quantity in Box	1	250V~50-60Hz 10A
Quantity in Carton	12	
Carton (N/G) Weight Kg.	4,72 / 5,19	
Carton m <sup>3</sup>	0,015	



PLASTİK FAN

PLASTIC FANS

ПЛАСТИКОВЫЕ ВЕНТИЛЯТОРЫ

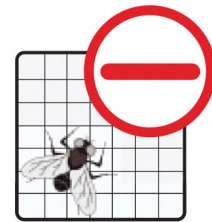

Operation Voltage	220-240V / 50-60Hz
Airflow	100m³/h
Speed	2250 rpm
Power	12W

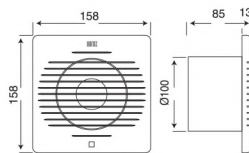

500-000-100

Quantity in Box	1
Quantity in Carton	20
Carton (N/G) Weight Kg.	8,8 / 10,3
Carton m³	0,047



Operation Voltage	220-240V / 50-60Hz
Airflow	120m³/h
Speed	1900 rpm
Power	15W

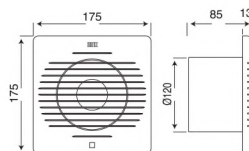

500-000-120

Quantity in Box	1
Quantity in Carton	20
Carton (N/G) Weight Kg.	9,7 / 11,22
Carton m³	0,059



Operation Voltage	220-240V / 50-60Hz
Airflow	150m³/h
Speed	1800 rpm
Power	20W

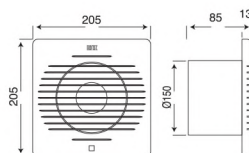

500-000-150

Quantity in Box	1
Quantity in Carton	20
Carton (N/G) Weight Kg.	13,9 / 15,91
Carton m³	0,098



Operation Voltage	220-240V / 50-60Hz
Airflow	200m³/h
Speed	2000 rpm
Power	40W

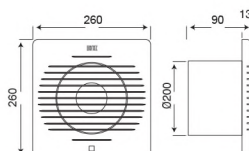

500-000-200

Quantity in Box	1
Quantity in Carton	10
Carton (N/G) Weight Kg.	13,3 / 14,8
Carton m³	0,093



## 360° SENSÖRLÜ TAVAN ARMATÜRÜ

LIGHTING FIXTURE WITH 360° MOTION SENSOR

ПОТОЛОЧНЫЙ СВЕТИЛЬНИК С 360° ДАТЧИКОМ ДВИЖЕНИЯ



400-001-112



400-002-112



400-000-112

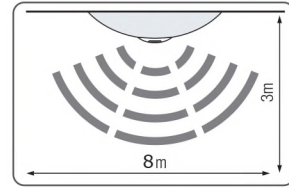

Quantity in Box	1
Quantity in Carton	10
Carton (N/G) Weight Kg.	8,40 / 11,19
Carton m <sup>3</sup>	0,11

230V~50-60Hz  
max 2x25W

**KULLANIM ALANLARI**  
Merdiven Aydınlatmaları  
Bina Girişleri  
Koridorlar  
Kapalı Otoparklar  
Otel, Hastane, Okul,  
Akaryakıt İstasyonları...



E27 Max 2x25W

**360° SENSÖRLÜ TAVAN ARMATÜRÜ**  
ALGILAMA MESAFESİ : 8m (max)  
ZAMAN AYAR ARALIĞI : 15-270sn  
ORTAM IŞIK AYAR ARALIĞI: 2-240Lux  
ÇALIŞMA SICAKLIĞI : -20°/+75°  
KORUMA SINIFI : IP20



NEMLİ YER / WATERPROOF / ВОДОНЕПРОНИЦАЕМЫЙ

AQUA YARIMAY MİKROSENSÖRLÜ E27 / AQUA HALFMOON WITH MICRO SENSOR E27 /  
АКУА ПОЛУМЕСЯЦ С МИКРО СЕНСОРОМ E27



SIYAH - OPAL / BLACK - OPAL  
/ ЧЁРНЫЙ - ОПАЛ

E27+Sensör

400 223 114



360°  
MICROSENSOR



BEYAZ - OPAL / WHITE - OPAL  
/ БЕЛЫЙ - ОПАЛ

E27+Sensör

400 213 114

Quantity in Box	1	230V~50-60HZ max 40W
Quantity in Carton	20	
Carton (N/G) Weight Kg.	7,9 / 10	
Carton m <sup>3</sup>	0.112	

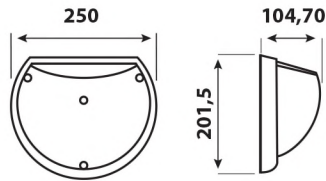



NEMLİ YER / WATERPROOF / ВОДОНЕПРОНИЦАЕМЫЙ

AQUA DOLUNAY MİKROSENSÖRLÜ E27 / AQUA FULLMOON WITH MICRO SENSOR E27 /  
АКУА ПОЛНАЯ ЛУНА С МИКРО СЕНСОРОМ E27



SİYAH - OPAL / BLACK - OPAL  
/ ЧЁРНЫЙ - ОПАЛ

E27+Sensör

400 223 115



360°  
MICROSENSOR



BEYAZ - OPAL / WHITE - OPAL  
/ БЕЛЫЙ-ОПАЛ

E27+Sensör

400 213 115

Quantity in Box	1
Quantity in Carton	16
Carton (N/G) Weight Kg.	7,3 / 9,4
Carton m <sup>3</sup>	0,104

230V~50-60Hz  
max 40W

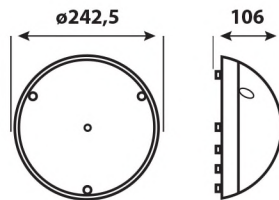



NEMLİ YER / WATERPROOF / ВОДОНЕПРОНИЦАЕМЫЙ

AQUA YARIMAY LEDLİ SENSÖRLÜ / LED AQUA HALFMOON WITH MICRO SENSOR /  
АКУА ПОЛУМЕСЯЦ СВЕТОДИОДНЫЙ С МИКРО СЕНСОРОМ



SİYAH - OPAL / BLACK - OPAL  
/ ЧЁРНЫЙ - ОПАЛ

Led+Sensör

9W 3000K

400 423 114

9W 6400K

400 425 114

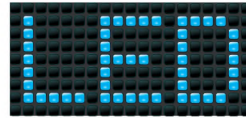

360°  
MICROSENSOR



BEYAZ - OPAL / WHITE - OPAL  
/ БЕЛЫЙ-ОПАЛ

Led+Sensör

9W 3000K

400 413 114

9W 6400K

400 415 114

Quantity in Box	1	230V~50-60Hz
Quantity in Carton	20	
Carton (N/G) Weight Kg.	7,970 / 10,21	
Carton m <sup>3</sup>	0,11	

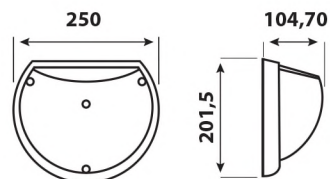



NEMLİ YER / WATERPROOF / ВОДОНЕПРОНИЦАЕМЫЙ

AQUA DOLUNAY LEDLİ SENSÖRLÜ / LED AQUA FULLMOON WITH MICRO SENSOR /  
АКУА ПОЛНАЯ ЛУНА СВЕТОДИОДНЫЙ С МИКРО СЕНСОРОМ



SİYAH - OPAL / BLACK - OPAL  
/ ЧЁРНЫЙ - ОПАЛ

Led+Sensör

12W 3000K

400 423 115

12W 6400K

400 425 115

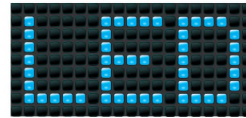

360°  
MICROSENSOR



BEYAZ - OPAL / WHITE - OPAL  
/ БЕЛЫЙ-ОПАЛ

Led+Sensör

12W 3000K

400 413 115

12W 6400K

400 415 115



Quantity in Box	1
Quantity in Carton	16
Carton (N/G) Weight Kg.	6,795 / 8,94
Carton m <sup>3</sup>	0,10

230V~50-60Hz

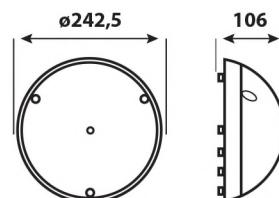



NEMLİ YER / WATERPROOF / ВОДОНЕПРОНИЦАЕМЫЙ

TOROS NEMLİYER ARMATÜRÜ / TOROS ALUMINIUM BULKHEAD LAMP /  
ТОРОС ПЫЛЕВЛАГОЗАЩИЩЕННЫЙ СВЕТИЛЬНИК



SİYAH / BLACK  
ЧЁРНЫЙ

E27

400 001 119



BEYAZ / WHITE  
БЕЛЫЙ

E27

400 000 119



Quantity in Box	1	230V~50-60Hz max 60W
Quantity in Carton	20	
Carton (N/G) Weight Kg.	10,5 / 12,1	
Carton m <sup>3</sup>	0,04	

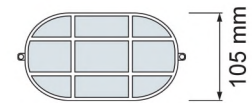
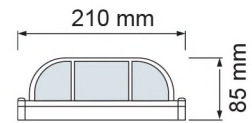





NEMLİ YER / WATERPROOF / ВОДОНЕПРОНИЦАЕМЫЙ

AQUA EKO / AQUA ECO / АКВА ЭКО



SİYAH / BLACK  
ЧЁРНЫЙ

400-000-108



BEYAZ / WHITE  
БЕЛЫЙ

400-001-108

Quantity in Box	1
Quantity in Carton	16
Carton (N/G) Weight Kg.	6,42 / 7,93
Carton m <sup>3</sup>	0,084

250V~50-60Hz  
max 26W(ESL)

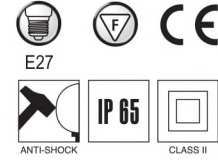
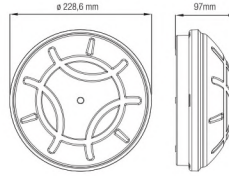

AQUA OPAK APLİK / AQUA OPAK WALL FIXTURE / АКВА ОПАК



SİYAH / BLACK  
ЧЁРНЫЙ

400-001-113



BEYAZ / WHITE  
БЕЛЫЙ

400-000-113

Quantity in Box	1
Quantity in Carton	24
Carton (N/G) Weight Kg.	6,5 / 8,5
Carton m <sup>3</sup>	0,091

230V~50-60Hz  
max 26W(ESL)

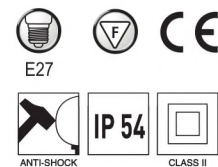
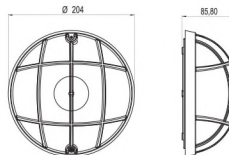



NEMLİ YER / WATERPROOF / ВОДОНЕПРОНИЦАЕМЫЙ

AQUA APLİK / AQUA WALL FIXTURE / АКУА НАСТЕННЫЙ СВЕТИЛЬНИК

BEYAZ / WHITE  
БЕЛЫЙ

400-000-111

SİYAH / BLACK  
ЧЁРНЫЙ

400-002-111



Quantity in Box	1	230V~50-60HZ max 26W(ESL)
Quantity in Carton	20	
Carton (N/G) Weight Kg.	4,74 / 6,27	
Carton m <sup>3</sup>	0,066	

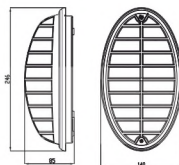



NEMLİ YER / WATERPROOF / ВОДОНЕПРОНИЦАЕМЫЙ

AQUA OPAL / AQUA OPAL / АКУА ОПАЛ

OPAL / OPAL / ОПАЛ



BEYAZ / WHITE  
БЕЛЫЙ

400-010-105



SİYAH / BLACK  
ЧЕРНЫЙ

400-011-105



GRİ / GREY  
СЕРЫЙ

400-012-105

BUZLU / FROSTED / ИНЕЙ



BEYAZ / WHITE  
БЕЛЫЙ

400-000-105



SİYAH / BLACK  
ЧЕРНЫЙ

400-001-105



GRİ / GREY  
СЕРЫЙ

400-002-105

Quantity in Box	1	230V~50-60Hz max 60W
Quantity in Carton	10	
Carton (N/G) Weight Kg.	6,06 / 7,57	
Carton m <sup>3</sup>	0,081	

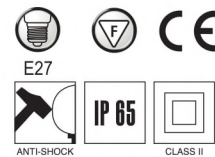
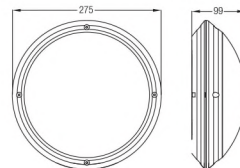



**NEMLİ YER / WATERPROOF / ВОДОНЕПРОНИЦАЕМЫЙ**

**AQUA OVAL OPAL / AQUA OVAL OPAL / АКУА ОПАЛ ОВАЛЬНЫЙ**

**OPAL / OPAL / ОПАЛ**



BEYAZ / WHITE  
БЕЛЫЙ

400-010-106



SİYAH / BLACK  
ЧЕРНЫЙ

400-011-106



GRİ / GREY  
СЕРЫЙ

400-012-106

**BUZLU / FROSTED / ИНЕЙ**



BEYAZ / WHITE  
БЕЛЫЙ

400-000-106



SİYAH / BLACK  
ЧЕРНЫЙ

400-001-106



GRİ / GREY  
СЕРЫЙ

400-002-106

Quantity in Box	1
Quantity in Carton	10
Carton (N/G) Weight Kg.	8,04 / 9,54
Carton m <sup>3</sup>	0,082

230V~50-60Hz  
max 60W

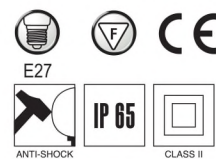
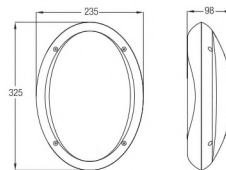



NEMLİ YER / WATERPROOF / ВОДОНЕПРОНИЦАЕМЫЙ

AQUA YARIMAY E27 / AQUA HALFMOON E27 / АКУА ПОЛУМЕСЯЦ E27



SİYAH - OPAL / BLACK - OPAL  
/ ЧЁРНЫЙ - ОПАЛ

E27

400 123 114



BEYAZ - OPAL / WHITE - OPAL  
/ БЕЛЫЙ - ОПАЛ

E27

400 113 114



SİYAH - BUZLU / BLACK - FROST  
/ ЧЁРНЫЙ - ИНЕЙ

E27

400 124 114



BEYAZ - BUZLU / WHITE - FROST  
/ БЕЛЫЙ - ИНЕЙ

E27

400 114 114



Quantity in Box	1	230V~50-60Hz max 40W
Quantity in Carton	20	
Carton (N/G) Weight Kg.	7,2 / 9,3	
Carton m <sup>3</sup>	0.112	

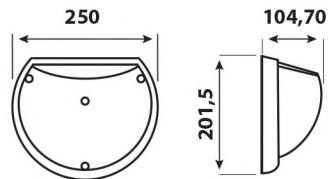



NEMLİ YER / WATERPROOF / ВОДОНЕПРОНИЦАЕМЫЙ

AQUA DOLUNAY E27 / AQUA FULLMOON E27 / АКУА ПОЛНАЯ ЛУНА E27



SİYAH - OPAL / BLACK - OPAL  
/ ЧЁРНЫЙ - ОПАЛ

E27

400 123 115



BEYAZ - OPAL / WHITE - OPAL  
/ БЕЛЫЙ - ОПАЛ

E27

400 113 115



SİYAH - BUZLU / BLACK - FROST  
/ ЧЁРНЫЙ - ИНЕЙ

E27

400 124 115

BEYAZ - BUZLU / WHITE - FROST  
/ БЕЛЫЙ - ИНЕЙ

E27

400 114 115

Quantity in Box	1	230V~50-60Hz max 40W
Quantity in Carton	16	
Carton (N/G) Weight Kg.	6 / 8,1	
Carton m <sup>3</sup>	0,104	

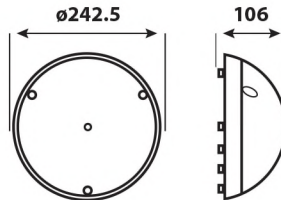



NEMLİ YER / WATERPROOF / ВОДОНЕПРОНИЦАЕМЫЙ

LEDLİ AQUA YARIMAY / AQUA HALFMOON LED / АКУА ПОЛУМЕСЯЦ СВЕТОДИОДНЫЙ



SİYAH - OPAL / BLACK - OPAL  
/ ЧЁРНЫЙ - ОПАЛ

LED

9W 3000K

400 323 114

9W 6400K

400 325 114

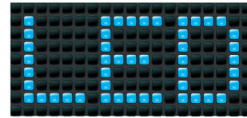

BEYAZ - OPAL / WHITE - OPAL  
/ БЕЛЫЙ - ОПАЛ

LED

9W 3000K

400 313 114

9W 6400K

400 315 114



Quantity in Box	1
Quantity in Carton	20
Carton (N/G) Weight Kg.	7,97 / 10,21
Carton m <sup>3</sup>	0,112

230V~50-60Hz

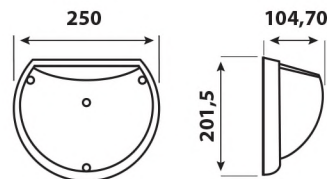



NEMLİ YER / WATERPROOF / ВОДОНЕПРОНИЦАЕМЫЙ

LEDLİ AQUA DOLUNAY / AQUA FULLMOON LED / АКУА ПОЛНАЯ ЛУНА СВЕТОДИОДНЫЙ



SIYAH - OPAL / BLACK - OPAL  
/ ЧЁРНЫЙ - ОПАЛ

LED

12W 3000K

400 323 115

12W 6400K

400 325 115

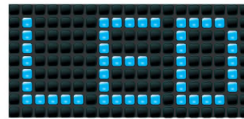

BEYAZ - OPAL / WHITE - OPAL  
/ БЕЛЫЙ - ОПАЛ

LED

12W 3000K

400 313 115

12W 6400K

400 315 115



Quantity in Box	1
Quantity in Carton	16
Carton (N/G) Weight Kg.	6,8 / 8,95
Carton m <sup>3</sup>	0,104

230V~50-60Hz

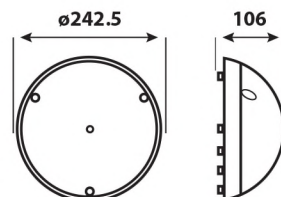





UFO / UFO / УФО

RÜZGAR GÜLÜ / WIND ROSE / РОЗА ВЕТРОВ

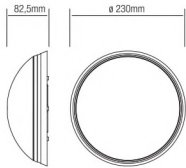

CEVİZ / WALNUT  
ОРЕХ

400-231-101

Quantity in Box	5	230V~50-60HZ max 15W(ESL)
Quantity in Carton	40	
Carton (N/G) Weight Kg.	10,6 / 10,85	
Carton m <sup>3</sup>	0,085	



GÜMÜŞ / SILVER  
СЕРЕБРО

400-201-101



FÜME / FUME  
ДЫМЧАТЫЙ

400-211-101



BEYAZ / WHITE  
БЕЛЫЙ

400-001-101



KAYIN / MAPLE  
БУК

400-221-101

NAZAR / NAZAR / НАЗАР



GÜMÜŞ / SILVER  
СЕРЕБРО

400-202-101



FÜME / FUME  
ДЫМЧАТЫЙ

400-212-101



CEVİZ / WALNUT  
ОРЕХ

400-232-101



KAYIN / MAPLE  
БУК

400-222-101



BEYAZ / WHITE  
БЕЛЫЙ

400-002-101

Quantity in Box	5	230V~50-60HZ max 15W(ESL)
Quantity in Carton	40	
Carton (N/G) Weight Kg.	11,42 / 11,66	
Carton m <sup>3</sup>	0,085	



UFO / UFO / УФО

ZAGREP / ZAGREP/ ЗАГРЕБ

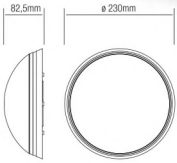

KAYIN / MAPLE  
БУК

400-223-101



GÜMÜŞ / SILVER  
СЕРЕБРО

400-203-101



FÜME / FUME  
ДЫМЧАТЫЙ

400-213-101



CEVİZ / WALNUT  
ОРЕХ

400-233-101



BEYAZ / WHITE  
БЕЛЫЙ

400-003-101

Quantity in Box	5	230V~50-60Hz max 15W(ESL)
Quantity in Carton	40	
Carton (N/G) Weight Kg.	11,02 / 11,3	
Carton m <sup>3</sup>	0,085	

ERCİYES / ERCİYES / ЭРДЖИЕС



BEYAZ / WHITE  
БЕЛЫЙ

400-004-101



FÜME / FUME  
ДЫМЧАТЫЙ

400-214-101



GÜMÜŞ / SILVER  
СЕРЕБРО

400-204-101



CEVİZ / WALNUT  
ОРЕХ

400-234-101



KAYIN / MAPLE  
БУК

400-224-101

Quantity in Box	5	230V~50-60Hz max 15W(ESL)
Quantity in Carton	40	
Carton (N/G) Weight Kg.	10,74 / 11,0	
Carton m <sup>3</sup>	0,085	

UFO / UFO / УФО

**YILDIZ / YILDIZ / ЗВЕЗДА**

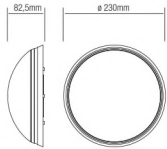

FÜME / FUME  
ДЫМЧАТЫЙ

400-124-101

Quantity in Box	5
Quantity in Carton	40
Carton (N/G) Weight Kg.	10,52 / 10,76
Carton m <sup>3</sup>	0,085

230V~50-60Hz  
max 15W(ESL)



GÜMÜŞ / SILVER  
СЕРЕБРО

400-123-101



BEYAZ / WHITE  
БЕЛЫЙ

400-022-101



CEVİZ / WALNUT  
ОРЕХ

400-126-101



KAYIN / MAPLE  
БУК

400-125-101

**LOLY / LOLLY / ЛОЛЛИ**

**NEW** OPEN-CLOSE SYSTEM  
WITHOUT SCREW

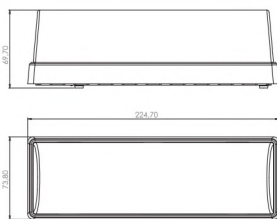

BEYAZ / WHITE  
БЕЛЫЙ

400-000-110

Quantity in Box	5
Quantity in Carton	60
Carton (N/G) Weight Kg.	9,63 / 10,78
Carton m <sup>3</sup>	0,054

230V~50-60Hz  
max 15W(ESL)



GLOP / GLOP / ГЛОП

RÜZGAR GÜLÜ / WIND ROSE / РОЗА ВЕТРОВ

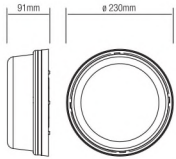

FÜME / FUME  
ДЫМЧАТЫЙ

400-211-100

Quantity in Box	4	230V~50-60Hz max 26W (ESL)
Quantity in Carton	32	
Carton (N/G) Weight Kg.	11,28 / 11,44	
Carton m <sup>3</sup>	0,085	



GÜMÜŞ / SILVER  
СЕРЕБРО

400-201-100



BEYAZ / WHITE  
БЕЛЫЙ

400-001-100



CEVİZ / WALNUT  
ОРЕХ

400-231-100



KAYIN / MAPLE  
БУК

400-221-100

FAVORİ / FAVORI / ФАВОРИ



GÜMÜŞ / SILVER  
СЕРЕБРО

400-202-100



FÜME / FUME  
ДЫМЧАТЫЙ

400-212-100



CEVİZ / WALNUT  
ОРЕХ

400-232-100



KAYIN / MAPLE  
БУК

400-222-100



BEYAZ / WHITE  
БЕЛЫЙ

400-002-100

Quantity in Box	4	230V~50-60Hz max 26W (ESL)
Quantity in Carton	32	
Carton (N/G) Weight Kg.	11,11 / 11,35	
Carton m <sup>3</sup>	0,085	



APLIK / WALL FIXTURE / НАСТЕННЫЙ СВЕТИЛЬНИК

FLUE / FLUE / ФЛУЕ



GÜMÜŞ / SILVER  
СЕРЕБРО

400-001-107



FÜME / FUME  
ДЫМЧАТЫЙ

400-002-107

BEYAZ / WHITE  
БЕЛЫЙ

400-000-107



CEVİZ / WALNUT  
ОРЕХ

400-003-107



KAYIN / MAPLE  
БУК

400-004-107

Quantity in Box	4	230V~50-60Hz max 26W (ESL)
Quantity in Carton	36	
Carton (N/G) Weight Kg.	8,01 / 9,28	
Carton m <sup>3</sup>	0,064	

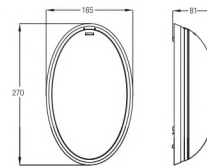

NİNOVA / NİNOVA / НИНОВА



GÜMÜŞ / SILVER  
СЕРЕБРО

400-011-107



FÜME / FUME  
ДЫМЧАТЫЙ

400-012-107



CEVİZ / WALNUT  
ОРЕХ

400-013-107



KAYIN / MAPLE  
БУК

400-014-107



BEYAZ / WHITE  
БЕЛЫЙ

400-010-107



UFO ÇİFT DUYLU / UFO WITH TWO LAMP HOLDERS / УФО С ДВУМЯ ПАТРОНАМИ

**BULUT / BULUT / ОБЛАКО**



CEVİZ / WALNUT  
OPEX

400-030-104

Quantity in Box	1	230V~50-60Hz max 2x28W (ESL)
Quantity in Carton	5	
Carton (N/G) Weight Kg.	3,50 / 4,90	
Carton m <sup>3</sup>	0,089	

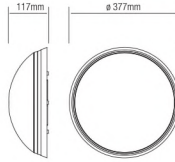

GÜMÜŞ / SILVER  
СЕРЕБРО

400-010-104



ALTIN / GOLD  
МАТОВОЕ ЗОЛОТО

400-020-104



BEYAZ / WHITE  
БЕЛЫЙ

400-000-104



KAYIN / MAPLE  
БУК

400-040-104

**ZAGREP / ZAGREP / ЗАГРЕБ**



GÜMÜŞ / SILVER  
СЕРЕБРО

400-011-104



ALTIN / GOLD  
МАТОВОЕ ЗОЛОТО

400-021-104



CEVİZ / WALNUT  
OPEX

400-031-104



KAYIN / MAPLE  
БУК

400-041-104



BEYAZ / WHITE  
БЕЛЫЙ

400-001-104



KARE ARMATÜR / SQUARE LIGHTING FIXTURE / КВАДРАТНАЯ АРМАТУРА

**KARE KLASİK / SQUARE CLASSIC /  
КВАДРАТНАЯ КЛАССИКА**

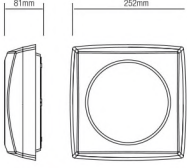

BEYAZ / WHITE  
БЕЛЫЙ

400-000-102

TEKLİ / 1 piece

DÖRTLÜ / 4 pieces

Quantity in Box	1
Quantity in Carton	12
Carton (N/G) Weight Kg.	4,78 / 6,21
Carton m <sup>3</sup>	0,066

Quantity in Box	4
Quantity in Carton	24
Carton (N/G) Weight Kg.	8,98 / 9,78
Carton m <sup>3</sup>	0,60

230V~50-60Hz  
max 2x26W (ESL)



GÜMÜŞ / SILVER  
СЕРЕБРО

400-010-102



ALTIN / GOLD  
МАТОВОЕ ЗОЛОТО

400-020-102



CEVİZ / WALNUT  
ОРЕХ

400-030-102



KAYIN / MAPLE  
БУК

400-040-102

**KARE MODERN / SQUARE MODERN / КВАДРАТНЫЙ МОДЕРН**



GÜMÜŞ / SILVER  
СЕРЕБРО

400-011-102



ALTIN / GOLD  
МАТОВОЕ ЗОЛОТО

400-021-102



BEYAZ / WHITE  
БЕЛЫЙ

400-001-102



CEVİZ / WALNUT  
ОРЕХ

400-031-102



KAYIN / MAPLE  
БУК

400-041-102



Quantity in Box	1
Quantity in Carton	12
Carton (N/G) Weight Kg.	4,67 / 6,10
Carton m <sup>3</sup>	0,066

TEKLİ / 1 piece

DÖRTLÜ / 4 pieces

Quantity in Box	4
Quantity in Carton	24
Carton (N/G) Weight Kg.	8,62 / 9,42
Carton m <sup>3</sup>	0,60

230V~50-60Hz  
max 2x26W (ESL)



ÇİFT DUYLU KARE ARMATÜR / SQUARE FIXTURE WITH TWO LAMPHOLDER /  
КВАДРАТНАЯ АРМАТУРА С ДВУМЯ ПАТРОНАМИ

**KARE KLASİK / SQUARE CLASSIC /  
КВАДРАТНАЯ КЛАССИКА**

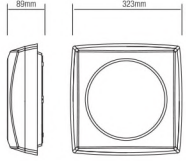

BEYAZ / WHITE  
БЕЛЫЙ

400-000-103

Quantity in Box	1
Quantity in Carton	10
Carton (N/G) Weight Kg.	8,51 / 9,71
Carton m <sup>3</sup>	0,10

230V~50-60Hz  
max 2x26W (ESL)



GÜMÜŞ / SILVER  
СЕРЕБРО

400-010-103



ALTIN / GOLD  
МАТОВОЕ ЗОЛОТО

400-020-103



CEVİZ / WALNUT  
ОРЕХ

400-030-103



KAYIN / MAPLE  
БУК

400-040-103

**KARE MODERN / SQUARE MODERN / КВАДРАТНЫЙ МОДЕРН**



GÜMÜŞ / SILVER  
СЕРЕБРО

400-011-103



ALTIN / GOLD  
МАТОВОЕ ЗОЛОТО

400-021-103



BEYAZ / WHITE  
БЕЛЫЙ

400-001-103



CEVİZ / WALNUT  
ОРЕХ

400-031-103



KAYIN / MAPLE  
БУК

400-041-103



Quantity in Box	1
Quantity in Carton	10
Carton (N/G) Weight Kg.	8,44 / 9,64
Carton m <sup>3</sup>	0,10

230V~50-60Hz  
max 2x26W (ESL)





BAHÇE AYDINLATMASI / GARDEN LAMP / САДОВО-ПАРКОВЫЕ СВЕТИЛЬНИКИ



BEYAZ - WHITE - БЕЛЫЙ

BEGONYA- 2

E27

400 020 117

Quantity in Box	1	230V~50-60Hz max 40W
Quantity in Carton	12	
Carton (N/G) Weight Kg.	4,75 / 6,42	
Carton m <sup>3</sup>	0,13	

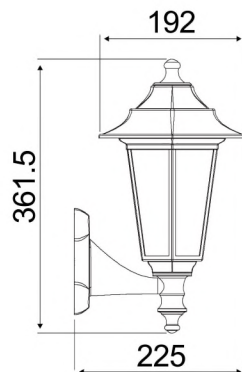

SİYAH - BLACK - ЧЁРНЫЙ

BEGONYA- 2

E27

400 010 117



BAHÇE AYDINLATMASI / GARDEN LAMP / САДОВО-ПАРКОВЫЕ СВЕТИЛЬНИКИ



BEYAZ - WHITE - БЕЛЫЙ

BEGONYA - 1

E27

400 020 116

Quantity in Box	1	230V~50-60Hz max 40W
Quantity in Carton	12	
Carton (N/G) Weight Kg.	4,75/ 6,42	
Carton m <sup>3</sup>	0,13	

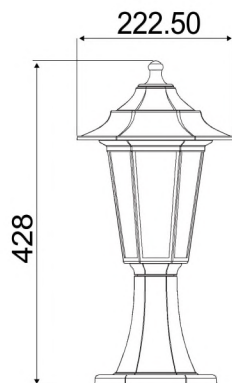

SİYAH - BLACK - ЧЁРНЫЙ

BEGONYA - 1

E27

400 010 116



BAHÇE AYDINLATMASI / GARDEN LAMP / САДОВО-ПАРКОВЫЕ СВЕТИЛЬНИКИ



SİYAH - BLACK - ЧЁРНЫЙ



BEYAZ - WHITE - БЕЛЫЙ



BEGONYA - 3

E27 400 010 118

BEGONYA - 3

E27 400 020 118

Quantity in Box	1
Quantity in Carton	12
Carton (N/G) Weight Kg.	4,75 / 6,42
Carton m <sup>3</sup>	0,13

230V~50-60Hz  
max 40W





BAHÇE AYDINLATMASI / GARDEN LAMP / САДОВО-ПАРКОВЫЕ СВЕТИЛЬНИКИ

BAHÇE APLİK / GARDEN WALL LAMP / НАСТЕННЫЙ СВЕТИЛЬНИК



SİYAH - BLACK - ЧЁРНЫЙ



BEYAZ - WHITE - БЕЛЫЙ

BAHÇE APLİK

E27

400 010 120

BAHÇE APLİK

E27

400 020 120

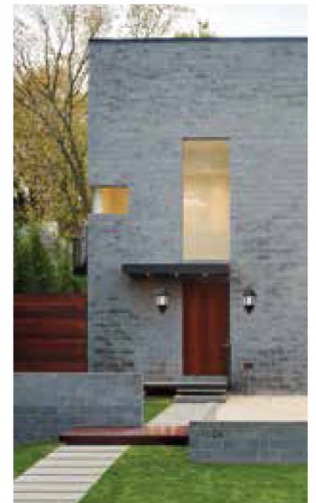

Quantity in Box	1	230V~50-60HZ max 40W
Quantity in Carton	24	
Carton (N/G) Weight Kg.	5,8 / 8,90	
Carton m <sup>3</sup>	0,15	

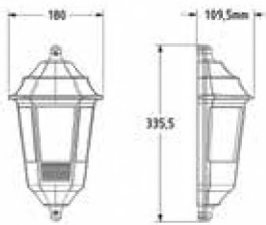



SİGORTA KUTUSU / DISTRIBUTION BOX / ЭЛЕКТРОЩИТОК

4'LÜ SIVAÜSTÜ / SURFACE MOUNT / НАКЛАДНОЙ



BEYAZ - WHITE - БЕЛЫЙ

600 010 400



SİYAH - BLACK - ЧЁРНЫЙ

600 001 400

4'LÜ SIVAALTI / FLUSH MOUNT / ВСТРАИВАЕМЫЙ



BEYAZ - WHITE - БЕЛЫЙ

600 000 401



SİYAH - BLACK - ЧЁРНЫЙ

600 001 401

SIVAÜSTÜ	SURFACE MOUNT	НАКЛАДНОЙ
Quantity in Box		1
Quantity in Carton		12
Carton (N/G) Weight Kg.		4,75 / 6,42
Carton m <sup>3</sup>		0,13

SIVAALTI	FLUSH MOUNT	ВСТРАИВАЕМЫЙ
Quantity in Box		1
Quantity in Carton		12
Carton (N/G) Weight Kg.		4,75 / 6,42
Carton m <sup>3</sup>		0,13





SİGORTA KUTUSU / DISTRIBUTION BOX / ЭЛЕКТРОЩИТОК

8'Lİ SIVAÜSTÜ / SURFACE MOUNT / НАКЛАДНОЙ



BEYAZ - WHITE - БЕЛЫЙ

600 000 800



SİYAH - BLACK - ЧЁРНЫЙ

600 001 800

8'Lİ SIVAALTI / FLUSH MOUNT / ВСТРАИВАЕМЫЙ



BEYAZ - WHITE - БЕЛЫЙ

600 000 801



SİYAH - BLACK - ЧЁРНЫЙ

600 001 801

SIVAÜSTÜ	SURFACE MOUNT	НАКЛАДНОЙ
Quantity in Box	1	
Quantity in Carton	24	
Carton (N/G) Weight Kg.	10,45 / 12,36	
Carton m <sup>3</sup>	0,104	

SIVAALTI	FLUSH MOUNT	ВСТРАИВАЕМЫЙ
Quantity in Box	1	
Quantity in Carton	24	
Carton (N/G) Weight Kg.	11,16 / 9,25	
Carton m <sup>3</sup>	0,104	





SİGORTA KUTUSU / DISTRIBUTION BOX / ЭЛЕКТРОЩИТОК

12'Lİ SIVAÜSTÜ / SURFACE MOUNT / НАКЛАДНОЙ



BEYAZ - WHITE - БЕЛЫЙ

600 000 120



SİYAH - BLACK - ЧЁРНЫЙ

600 001 120

12'Lİ SIVAALTI / FLUSH MOUNT / ВСТРАИВАЕМЫЙ



BEYAZ - WHITE - БЕЛЫЙ

600 000 121



SİYAH - BLACK - ЧЁРНЫЙ

600 001 121

SIVAÜSTÜ	SURFACE MOUNT	НАКЛАДНОЙ
Quantity in Box	1	
Quantity in Carton	12	
Carton (N/G) Weight Kg.	7,93 / 9,36	
Carton m <sup>3</sup>	0,091	

SIVAALTI	FLUSH MOUNT	ВСТРАИВАЕМЫЙ
Quantity in Box	1	
Quantity in Carton	12	
Carton (N/G) Weight Kg.	6,62 / 8,04	
Carton m <sup>3</sup>	0,091	





SİGORTA KUTUSU / DISTRIBUTION BOX / ЭЛЕКТРОЩИТОК

16'LI SIVAÜSTÜ / SURFACE MOUNT / НАКЛАДНОЙ



BEYAZ - WHITE - БЕЛЫЙ

600 000 160



SİYAH - BLACK - ЧЁРНЫЙ

600 001 160

16'LI SIVAALTI / FLUSH MOUNT / ВСТРАИВАЕМЫЙ



BEYAZ - WHITE - БЕЛЫЙ

600 000 161



SİYAH - BLACK - ЧЁРНЫЙ

600 001 161

SIVAÜSTÜ	SURFACE MOUNT	НАКЛАДНОЙ
Quantity in Box		1
Quantity in Carton		12
Carton (N/G) Weight Kg.		9,12 / 10,55
Carton m <sup>3</sup>		0,091

SIVAALTI	FLUSH MOUNT	ВСТРАИВАЕМЫЙ
Quantity in Box		1
Quantity in Carton		12
Carton (N/G) Weight Kg.		7,85 / 9,27
Carton m <sup>3</sup>		0,091





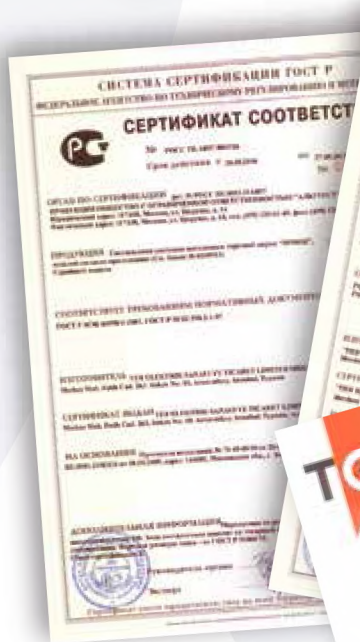
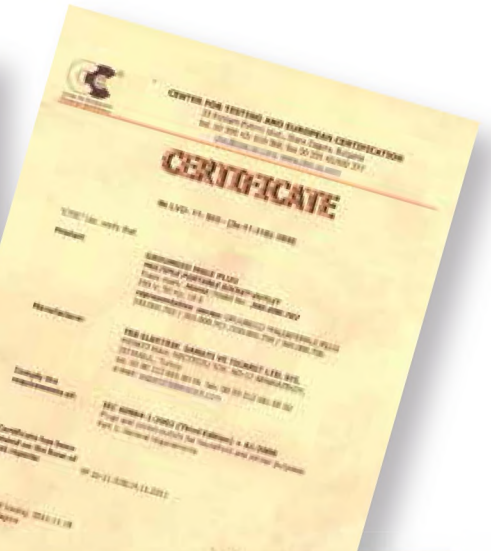

# ⋮⋮⋮ KaçmazGrup



[www.kacmazgroup.com](http://www.kacmazgroup.com)

- 

HOROZ ELECTRIC & ELECTRONIC TRADE CO. TURKEY
- 

HOROZ ELECTRIC HONG KONG
- 

HOROZ AYDINLATMA TURKEY
- 

IREM ELEKTRİK TURKEY
- 

HOROZ ELECTRIC COMPANY IRAQ
- 

HOROZ RUS MOSCOW, RUSSIA
- 

HOROZ EUROPE BRUSSELS, BELGIUM
- 

HOROZ ELECTRIC ROMANIA BUCHAREST, ROMANIA
- 

HOROZ UKRAINE KIEV, UKRAINE
- 

HOROZ ASIA ALMATY, KAZAKHSTAN
- 

HOROZ KIRGHIZSTAN, KIRGHIZSTAN
- 

HOROZ AZERBAIJAN BAKU, AZERBAIJAN
- 

TEB ELEKTRİK TURKEY
- 

ORKA CONSTRUCTION TURKEY
- 

ROYAL SANAT CONSTRUCTION TURKEY
- 

KORAY BIANCO CONSTRUCTION TURKEY